

FURUNO

FULL-CIRCLE COLOR SCANNING SONAR

Model

CSH-8L MARK-2

- ▶ Full-circle scanning sonar detects and instantaneously displays fish schools and underwater conditions
- ▶ Vivid 16-color display assists in recognition of bottom structure, concentration and distribution of fish schools
- ▶ Various fishing and navigation data* keeps operator abreast of fishing and navigation conditions
*Requires appropriate sensors
- ▶ Four user-programmable function keys for quick set up according to fishing conditions or specific function
- ▶ High power transmitter ensures reliable operation under any conditions
- ▶ Transducer frequency: 85 kHz



Photo: Control unit with optional monitor MU-150HD

www.furuno.com

A compact, high frequency sonar with revolutionary discrimination between bottom fish and seabed

The CSH-8L MARK-2 is a full-circle scanning sonar that rapidly detects and displays individual fish, schools of fish and changing underwater conditions. Fish distribution and seabed conditions are shown in 16 colors, 360 degrees around your vessel.

The CSH-8L MARK-2 is an 85 kHz high frequency sonar, which makes it ideal for searching near the vessel or in shallow water because of its narrow beam width and enhanced target identification capability. Fish and bottom echoes are clearly separated and bait fish are more easily captured. With automatic tilt scanning as a standard feature, the CSH-8L MARK-2 is suitable for both midwater trawlers and purse seiners.

The CSH-8L MARK-2 is provided in a BlackBox configuration for space saving and flexible installation. It consists of a compact hull unit, transceiver unit and processor unit. A variety of monitors are available to suit your installation and operational requirements. FURUNO's MU-series displays are specially designed to meet the requirements of marine professionals around the world. For a remote station, a second display and remote control can be simply plugged into the processor unit.

What is Scanning Sonar?

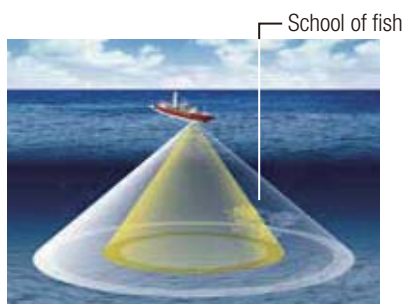

Detection image of scanning sonar

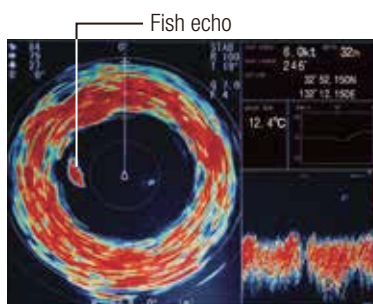

Fish echo displayed on CSH-8L MARK-2

The transducer of a scanning sonar consists of many elements to transmit the echo in all directions simultaneously without rotating the transducer. The echo is redrawn on the display instantaneously according to the latest feedback from the transducer. Because this sonar scans quickly, it greatly improves the fishing operation, especially when searching for/following fast swimming fish.

► Extremely Quick Scanning Speed

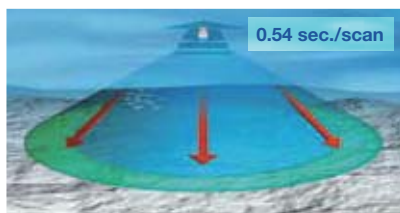

The CSH-8L MARK-2 completes a scan within 0.54 seconds/scan while the conventional PPI sonar^{*1} takes 32 seconds to train full circle under the same range/conditions^{*2}. Scanning sonar is capable of providing information that is about 60 times more comprehensive than PPI sonars. Fast scanning lessens the chance of missing a small change in underwater conditions. This is especially helpful when range and tilt require frequent adjustment while fishing, offering no frustration on redrawing time.

*1 CH-250 PPI sonar, training at 6° steps.

*2 Based on 400 m range in combination display mode.

► No Blind Area

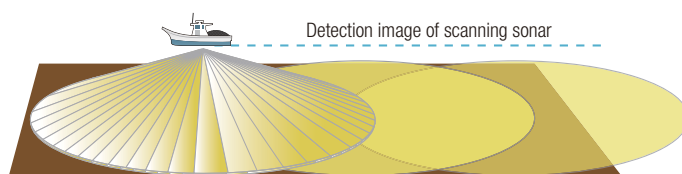

Scanning Sonar shows the actual situation 360 degrees around the vessel, and gives all the necessary information as needed. No more blind areas to consider, allowing the operator to concentrate on the tilt, range, fishing area, etc.

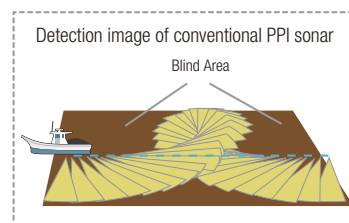

Selectable User-Friendly Operating Modes

There are three basic operating modes: normal sonar display (single scan), Echo sounder combination (single scan and echo sounder) and Audio combination (single scan and audio pictures).

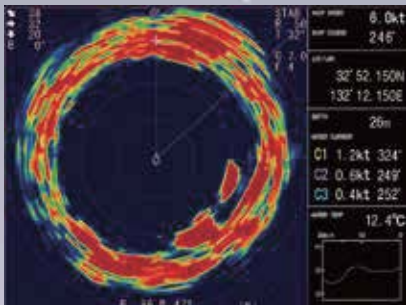

Sonar Display

Navigation data can be displayed in the text window, with connection of appropriate sensors. This mode is useful for detecting and tracking schools of fish.

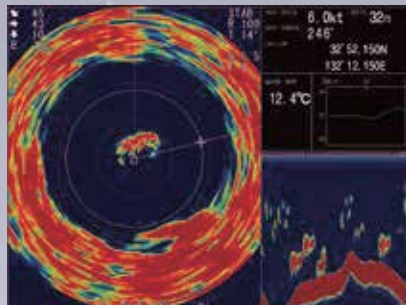

Sonar + Echo sounder*

The sonar picture appears on the left and the signal fed from the echosounder at the lower right side of the screen. This mode is suitable for judging fish school concentration.

*Interface with Echo sounder/Fish finder required

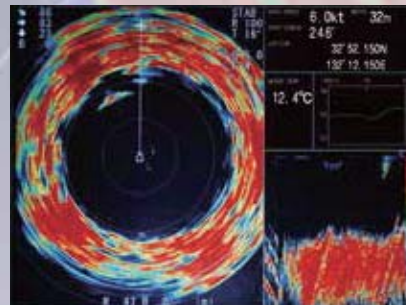

Sonar + Audio

Sonar picture appears on the left and the audio display at the lower right side of the screen. This mode is useful for analyzing echoes in a desired area.

Easy-to-Use Controls

The control unit of CSH-8L MARK-2 combines ergonomics and functions in a user-friendly manner. All controls respond quickly to the operator's command and the associated reaction can be seen on the screen immediately. Four user-defined functions can be assigned to Function keys (F1 to F4), providing for rapid setup and operation.

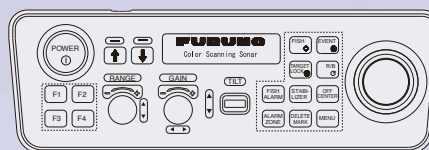

The optional remote controller provides armchair control of the tilt, range and gain.

Clear target presentation and discrimination



A horizontal view with minimum tilt angle, scanning sonar displays a vertical slice through the water. With its advanced detecting performance, the CSH-8L MARK-2 clearly discriminates the columns of bridge underwater.

Control unit with optional monitor MU-150HD

Model **CSH-8L MARK-2**

SPECIFICATIONS

1.PROCESSOR UNIT

Display Mode Single scan, Echo sounder combination* (single scan and echo sounder), Audio combination (single scan and audio pictures)
 *Echo sounder/Fish finder required

Colors Scan/echo: 16 colors, mark: 1 color

Mark Own ship's track, Heading line, Direction/ distance, Fish school, Event, Target lock

Menu Language English, Japanese, Chinese, Spanish, Danish, Dutch, French, Italian, Norwegian, Thai, Vietnamese, Burmese, Indonesian

2.TRANSCEIVER UNIT

Sonar Frequency 85 kHz

Range Scales 50, 85, 100, 150, 200, 250, 300, 350, 400, 450, 500, 600, 800, 1000, 1200, 1600 m
 0.5 to 20 ms (depending on range scales)

Pulselength 0.5 to 20 ms (depending on range scales)

Ship Speed 18 kn max (raise/lower operation up to 16 kn)

Tilt Manual control: 0° to 55° in 1° steps
 Automatic tilt scan: 4° to 52°

Audio Search Sector: 20°, 40°, 80° and 120° selectable
 Audio Output: 2 W, Frequency: 1 kHz

3.INTERFACE

Input Data NMEA 0183 Ver2.0/2.2
 RMC, VHW, VTG, HDG, HDM, HDT, DPT, DBT, DBS, CUR, VDR, GLC, GTD, MTW, RMA

Log, E/S, KP Speed log pulse (contact signal): 200/400 pulse/NM
 Sonde, E/S signal: VI-1100 A applicable
 External KP: Current loop, 0 to 12 V

Output Data NMEA 0183 Ver1.5/2.0/2.2
 TLL

Video Signal Output
Method RGB analog, separated synchronization, XGA (VESA)
Resolution 1024 x 768, 65.0 MHz clock

4.POWER SUPPLY

100/115/200/220/240 VAC, (Standard supply)
 50-60 Hz, 0.4 kVA (Raise 1 kVA)
 24 VDC (with optional DC-AC inverter)

EQUIPMENT LIST

- Standard**
1. Processor Unit CSH-5210
 2. Control Unit CSH-5211
 3. Transceiver Unit CSH-8030-8L
 4. Hull Unit 400 mm or 600 mm travel
 5. Installation Materials, Accessories and Spare Parts
- NOTE: Display Unit is not supplied as standard.

- Option**
1. DC-AC Inverter TR-2451
 2. E/S Interface Unit VI-1100A
 3. Aluminum Tank OP10-5 *1.0M*
 4. External Loudspeaker
 5. Transducer Cable Extension Kit
 6. Motion Sensor MS-100
 7. Remote Controller CSH-7040

Interconnection Diagram

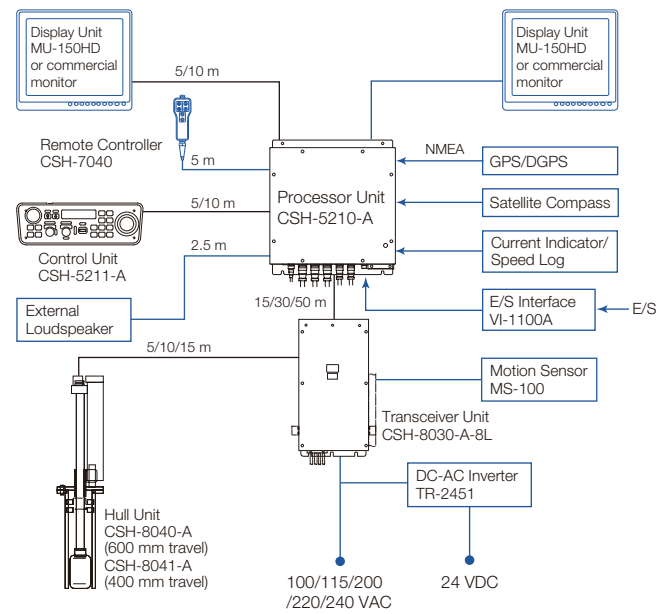

Transceiver Unit
CSH-8030-A-8L
 37 kg 81.6 lb

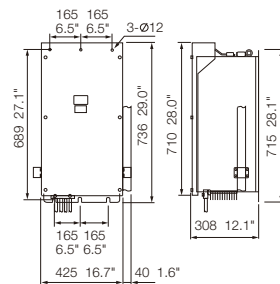

Hull Unit
CSH-8040-A (600 mm travel)
 82 kg 180.8 lb
CSH-8041-A (400 mm travel)
 81 kg 178.6 lb

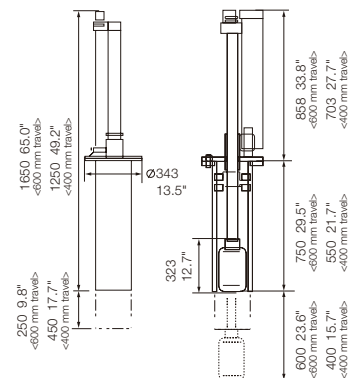

Control Unit
CSH-5211-A
 3.5 kg 7.7 lb

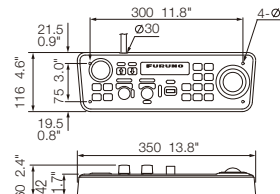

Processor Unit
CSH-5210-A
 3.4 kg 7.5 lb

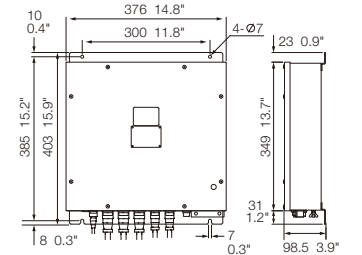

Beware of similar products

All brand and product names are registered trademarks, trademarks or service marks of their respective holders.

SPECIFICATIONS SUBJECT TO CHANGE WITHOUT NOTICE

FURUNO ELECTRIC CO., LTD.
 Japan | www.furuno.com
FURUNO U.S.A., INC.
 U.S.A. | www.furunousa.com
FURUNO PANAMA S.A.
 Republic of Panama | www.furuno.com.pa
FURUNO (UK) LIMITED
 U.K. | www.furuno.co.uk
FURUNO NORGE A/S
 Norway | www.furuno.no

FURUNO DANMARK A/S
 Denmark | www.furuno.dk
FURUNO SVERIGE AB
 Sweden | www.furuno.se
FURUNO FINLAND OY
 Finland | www.furuno.fi
FURUNO POLSKA Sp. z o.o.
 Poland | www.furuno.pl
FURUNO DEUTSCHLAND GmbH
 Germany | www.furuno.de

FURUNO FRANCE S.A.S.
 France | www.furuno.fr
FURUNO ESPAÑA S.A.
 Spain | www.furuno.es
FURUNO ITALIA S.R.L.
 Italy | www.furuno.it
FURUNO HELLAS S.A.
 Greece | www.furuno.gr
FURUNO (CYPRUS) LTD
 Cyprus | www.furuno.com.cy

FURUNO EURUS LLC
 Russian Federation | www.furuno.ru
FURUNO SHANGHAI CO., LTD.
 China | www.furuno.com/cn
FURUNO CHINA CO., LTD.
 Hong Kong | www.furuno.com/cn
FURUNO SINGAPORE
 Singapore | www.furuno.sg

PT FURUNO ELECTRIC INDONESIA
 Indonesia | www.furuno.id