

**SPECIFICATIONS OF FCV-295**

**GENERAL**

**1. Operating Frequencies**

The synthesized transceiver works with dual frequencies in 28 to 200 kHz. Specify transducer type when ordering, among 28/38/50/68/82/88/107/150/200 kHz

**2. Output Power**

1/2/3 kW

**3. Power Reduction**

Auto/10 to 100% (in 10% step)

**4. Tx Rate**

20 to 3000/min

**5. Pulselength**

Short1/Short2/Standard/Long/Manual (Manual Pulselength: 0.1 to 5.0 ms)

**6. RX Band**

Narrow/Standard/Wide

**7. Amplifier**

High dynamic range

**DISPLAY**

**1. Display**

10.4" color LCD (VGA: 640 x 480)

**2. Color**

8/16/64

**3. Brightness**

450 cd/m<sup>2</sup>

**4. Ranges**

5 to 3000 m (Split Range available)

**5. Shift**

0 to 2000 m

**6. Marker Zoom/Bottom-lock Expansion Ranges**

5 to 2000 m

**7. Display mode**

Single (HF/LF), Dual, Single + Zoom, two Custom Modes  
Zoom Mode (Bottom Lock, Bottom Zoom, Marker Zoom), Mix Mode, Nav data, A-scope

**8. Picture Advance Direction**

Left, Right, L/R

**9. Picture Advance Speed**

Stop, 1/16, 1/8, 1/4, 1/2, 1/1, 2/1, 4/1, Synchronized with own ship speed

**10. Alarms**

Audio-visual alarms for a preset depth of water, fish and a preset value of water temperature

**11. Language**

English, French, Spanish, German, Italian, Portuguese, Swedish, Danish, Norwegian, Finish, Greek, Chinese, Japanese, Thai, Korean, Russian

**12. Others**

Auto Mode, Interference, Clutter, TVG, Color Erase, Hue, Temp Graph, A-scope, White Marker

**DATA INTERFACE**

**NMEA0183 (Ver. 1.5, 2.0 or 3.0; Any talker)**

Input: BWC, GGA, GLC, GLL, GNS, GTD, HDG, HDT, MDA, MTW, MWV, RMA, RMB, RMC, VHW, VTG, XTE

Output: DBT, DPT, DBS, MTW, TLL, SDmrk, VHW, RMB, dat

**ENVIRONMENTAL CONDITIONS**

Display Unit: -15 °C to +55 °C (IEC60945 tested)

Water Resistance: IP55 (When flush mounted)

**POWER SUPPLY**

12-24 VDC, 45 W max. 100/110/220/230 VAC with optional rectifier

**EQUIPMENT LIST**

**Standard**

1. Display Unit
2. Installation Materials and Standard Spare Parts

**Option**

1. Speed/temperature sensor  
ST-02MSB (Thru-hull, bronze), ST-02PSB (Thru-hull, plastic)
2. Temperature sensor  
T-02MSB (Thru-hull, bronze), T-02MTB (Transom, bronze), T-03MSB (Thru-hull, bronze)
3. NMEA cable MJ-A6SPF0003-050C (5 m)  
CO-SPEVV-SB-C 2P x 0.2SQLF (5/10/15 m)
4. Rectifier PR-62
5. Transducer (Specify the frequency and type of transducer)
  - 1 kW: 28F-8 (28 kHz), 50B-6/6B (50 kHz), 50B-9B (50 kHz), 68F-8H (68 kHz), 88B-8 (88kHz), 200B-5S (200 kHz), 50/200-1T (50/200 kHz), 50/200-12M (50/200 kHz)
  - 2 kW: 28F-18 (28 kHz), 28BL-6HR (28 kHz), 38BL-9HR (38 kHz), 50B-12 (50 kHz), 50BL-12/12HR (50 kHz), 82B-35R (82 kHz), 88B-10 (88 kHz), 200B-8/8B (200 kHz)
  - 3 kW: 28F-24H (28 kHz), 28BL-12HR (28 kHz), 38BL-15HR (38 kHz), 50F-24H (50 kHz), 50BL-24H/24HR (50 kHz), 68F-30H (68 kHz), 88F-126H (88 kHz), 100B-10R (100 kHz), 150B-12H (150 kHz), 200B-12H (200 kHz)

**DISPLAY UNIT FCV-295**

7.0 kg 15.4 lb

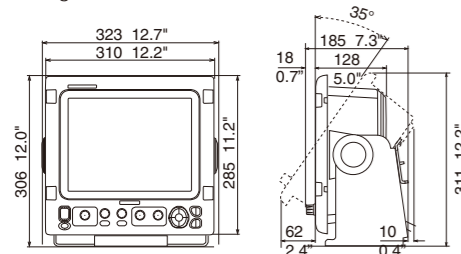

**Flush mount**

6.0 kg 13.2 lb

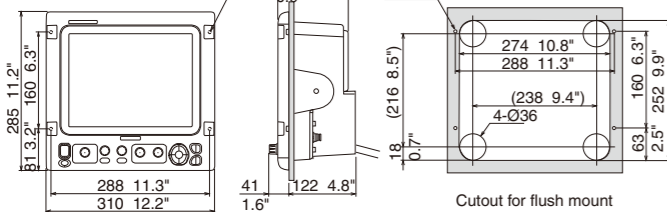

**INTERCONNECTION DIAGRAM**

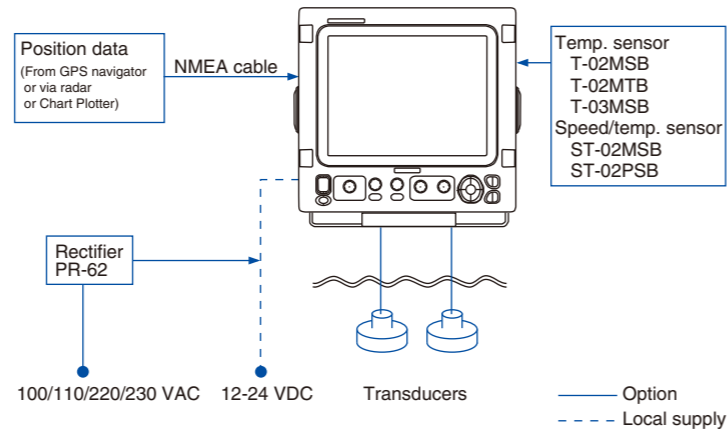

SPECIFICATIONS SUBJECT TO CHANGE WITHOUT NOTICE  
All brand and product names are registered trademarks, trademarks or service marks of their respective holders

**FURUNO ELECTRIC CO., LTD.**  
Nishinomiya, Hyogo, Japan  
www.furuno.co.jp

**FURUNO U.S.A., INC.**  
Camas, Washington, U.S.A.  
www.furunousa.com

**FURUNO (UK) LIMITED**  
Havant, Hampshire, U.K.  
www.furuno.co.uk

**FURUNO FRANCE S.A.S.**  
Bordeaux-Mérignac, France  
www.furuno.fr

**FURUNO ESPAÑA S.A.**  
Madrid, Spain  
www.furuno.es

**FURUNO DANMARK AS**  
Hvidovre, Denmark  
www.furuno.dk

**FURUNO NORGE A/S**  
Ålesund, Norway  
www.furuno.no

**FURUNO SVERIGE AB**  
Västra Frölunda, Sweden  
www.furuno.se

**FURUNO FINLAND OY**  
Espoo, Finland  
www.furuno.fi

**FURUNO POLSKA Sp. z o.o.**  
Gdynia, Poland  
www.furuno.pl

**FURUNO DEUTSCHLAND GmbH**  
Rellingen, Germany  
www.furuno.de

**FURUNO EURUS LLC**  
St. Petersburg, Russian Federation  
www.furuno.ru

**FURUNO HELLAS S.A.**  
Piraeus, Greece

1004-pdf Printed in Japan  
Catalogue No. E-405d

**FURUNO**  
World Wide  
Warranty 2 YEARS

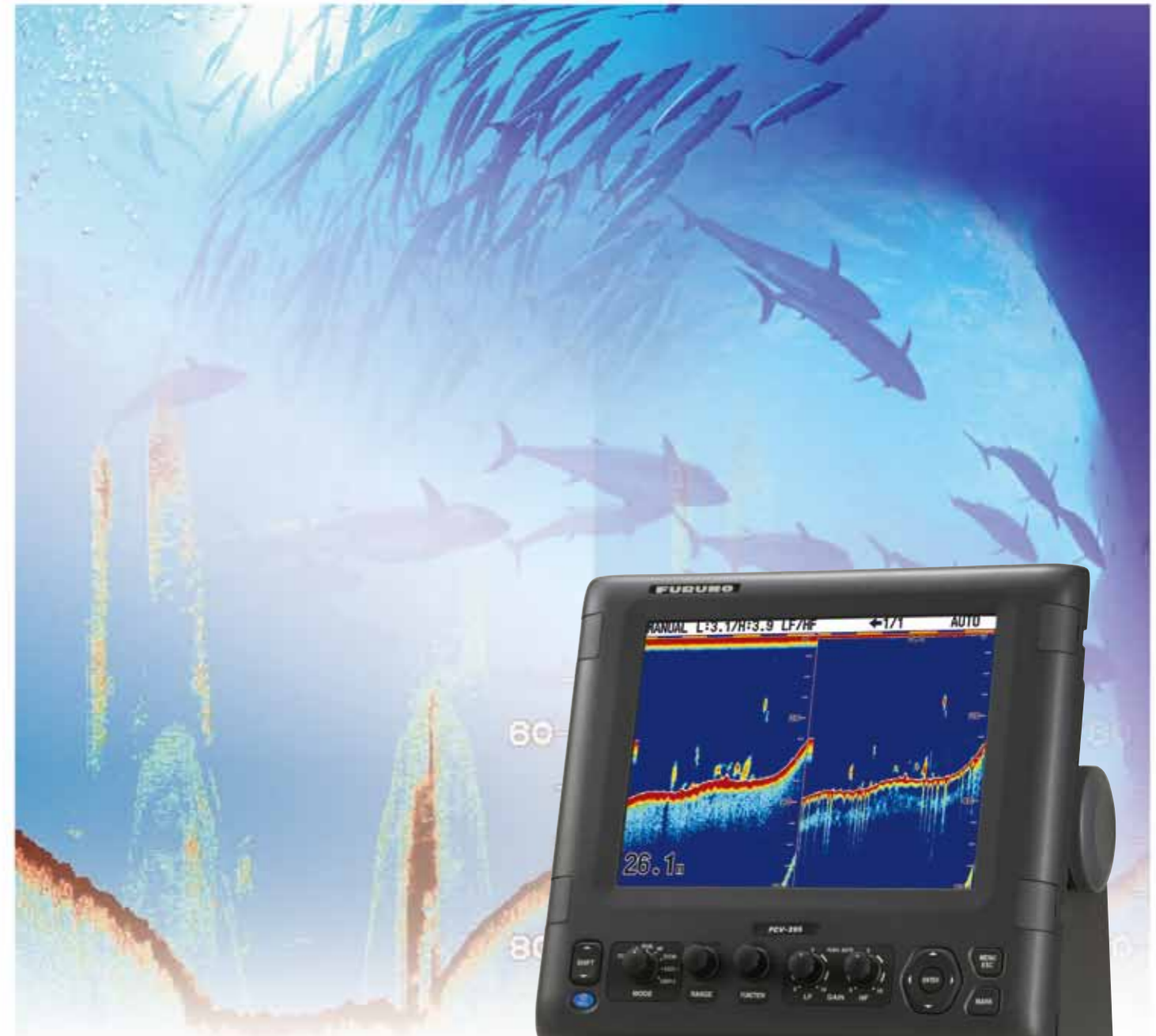

# New digital fish finder delivers crystal clear image of fish targets and bottom structure



The FCV-295 is a new color digital sounder designed for a variety of professional fishing operations. It features a bonded 10.4" LCD display providing superior viewing even in direct sunlight. You can display echoes in 8, 16, or 64 colors, with color assignment dependent on the strength of the returned echo.

The FURUNO Free Synthesizer (FFS) Transceiver allows a wide selection of operating frequencies. You may choose any two frequencies between 28 and 200 kHz to fit your fishing operation. Output power is selectable from 1, 2 or 3 kW. A wide variety of display modes and functions are available, which provide skippers with simple and intuitive information.

- ▶ 10.4" bonded color LCD provides clear view in any weather conditions
- ▶ Post-processing gain control applies to all existing returns on the display
- ▶ White Edge function trace the bottom contour with a thin white line
- ▶ FURUNO Digital Filter delivers crystal clear target presentation
- ▶ FURUNO Free Synthesizer transceiver allows adjustable operating frequency

## FURUNO Digital Filter

FURUNO digital filter optimizes the gain to obtain highly defined images of underwater conditions. The FCV-295 can clearly show target fish close to the seabed.

The digital filter also eliminates noise to deliver sharp and detailed echo presentation, achieving detection of fishing reef and even individual fish with absolute clarity.

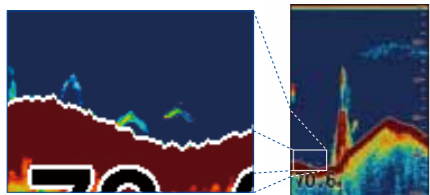

Fish targets close to the seabed

## White Edge

The top of the seabed is displayed in white to easily discern seabed structure from bottom fish returns. While conventional bottom discrimination function called "White Line" applied to the strongest echoes, the White Edge function enhances the discrimination of bottom fish and seabed by painting a very thin line above the bottom contour regardless of gain setting or display color.

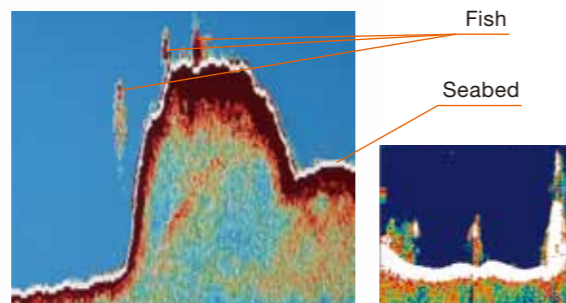

White Edge White Line

## Quick Gain Control

With the FCV-295's Quick Gain control, changes you make to Gain setting are applied not only to new echoes, but also to all past echoes on the screen. You can compare past and current echoes under the same Gain setting. Because the changes are applied to both new and existing returns, you can quickly and easily determine the right Gain setting for your conditions.

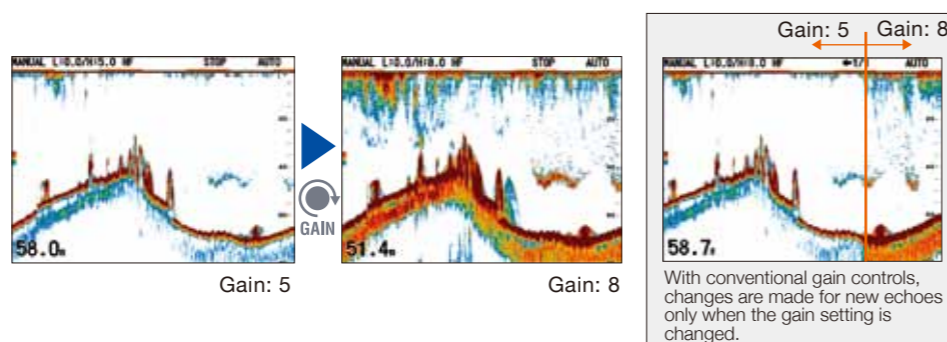

With conventional gain controls, changes are made for new echoes only when the gain setting is changed.

## Operating Frequency Adjustment

When FURUNO transducers are connected and set to the FCV-295, the operating frequency range will be registered and shown in the menu. The user can shift the operating frequency freely between the ranges at any time from the menu. With the FURUNO 82B-35R transducer, the operator can select any operating frequency from 66 to 109 kHz. This feature is particularly useful for vessels targeting many different species, or when the fish finders of other ships in the area cause interference.

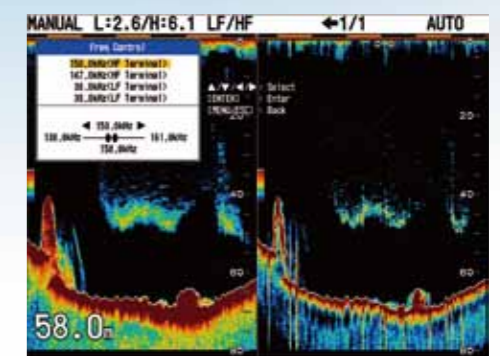

## Faster Transmission Rate For Detailed Detection

The rate of transmission is increased by more than 30% compared to conventional fish finders. As the result, more detailed information about underwater conditions can be gained through the same sounding interval. With the FCV-295's AUTO transmission function, the rate is automatically raised in shallow waters and lowered in deep waters, which provides for detailed detection of seabed targets.

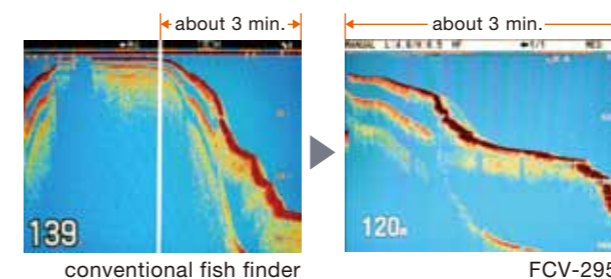

## Function Key

An often-used function such as TVG (Time Varied Gain) can be programmed and made available with the press of the Function key. This will give you access to any menu item without opening the menu.



### Functions which can be registered

Pic. Advance / Interference / Color Erase / Clutter / White Line / White Marker / TVG / STC / Bottom Zone / A-Scope / Split Range / Auto Shift / Freq Choice / Freq Control