

FURUNO

**12.1" COLOR LCD DISPLAY
DUAL-FREQUENCY SEARCHLIGHT SONAR**

Model **CH-600**

*Dual frequency, Dual views of
the Searchlight's Sonar power!*



More details on
www.furuno.com



Faster, easier, more reliable than ever

Incredibly fast training speed

NEW

Faster motor delivering quicker training speeds

Quick train speeds allow the sonar display to be refreshed at a faster rate aiding in earlier detection of fish and obstructions.

6 step angles for training speed adjustment according to user's needs

The CH-600 sonar is one of the most comprehensive and fastest sonars of its kind. It provides six selectable step variations (6°, 12°, 15°, 18°, 21° or 24°) for high scanning speed that can cover sector widths from 24° to 360° in a couple of seconds. Thanks to its high training speeds, the CH-600 can rapidly scan a large area providing the ultimate fishing and navigational experience.

Expert tip: When moving fast, you can use a wider step angle in order to get a glimpse of the surrounding area. If you detect something interesting, slow down and switch to a decreased step angle for clearer echoes.

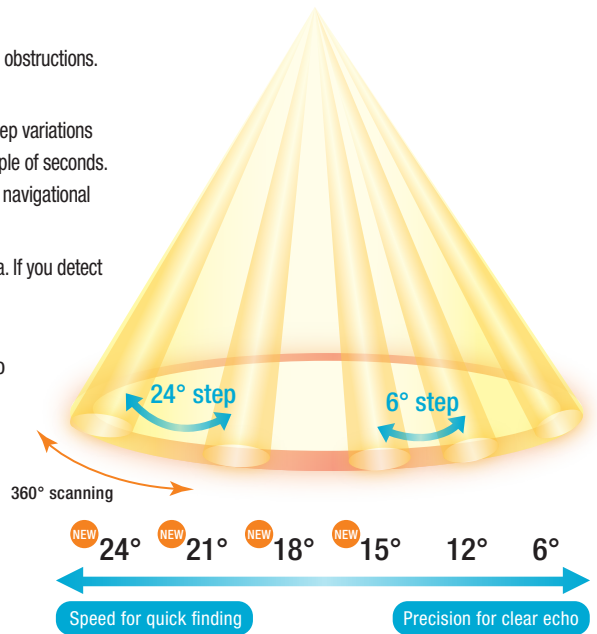
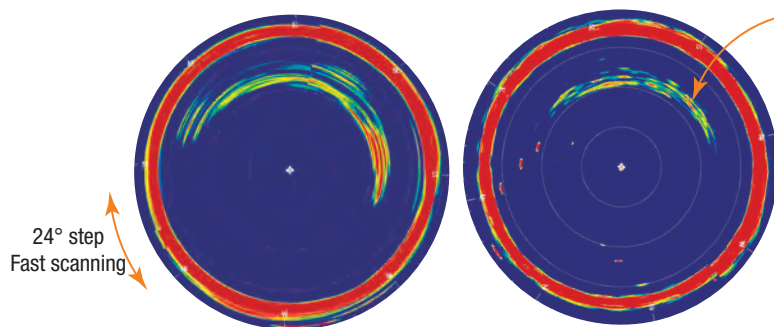

Full Circle Scanning Period(s) in seconds (150kHz)

No.		1	2	3	4	5	6	7	8	9	10	11	12	13	14	15
Range (m)		10	20	40	60	80	120	160	200	250	300	400	500	600	800	1000
Step Angle	6°	3.8	3.8	3.8	5.2	6.8	10.1	12.9	16.5	20.6	24.3	32.5	40.5	48.3	64.6	80.5
	15°	3.7	3.7	3.7	3.8	4.8	5.6	7.2	8.4	10.1	12	15	18.2	21.6	27.8	34.1
	24°	3.7	3.7	3.7	3.7	3.9	4.5	5.8	6.6	7.7	8.8	10.7	12.8	15	18.7	22.6

Built-in motion sensor provides stabilized target presentations in rough sea conditions

The CH-600 searchlight sonar is the first of its class to have integrated motion sensors. In rough seas, vessels tend to move in every direction. This movement can cause inaccurate target information to be displayed. The role of the integrated motion sensors is to precisely compensate for those negative effects and provide accurate data to the user.

On the picture: You can see that once the stabilizer is activated, the echo recovers its circular shape and is able to provide accurate data, no matter the sea conditions, the boat speed and inclination.

Thanks to the built-in stabilizer's compensation, the CH-600 is able to detect fish that didn't appear originally with the non-stabilized echo.

Stabilizer OFF

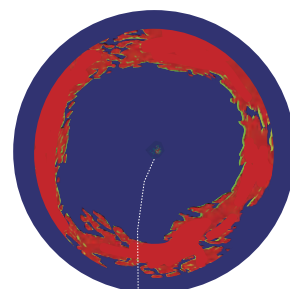

Stabilizer ON

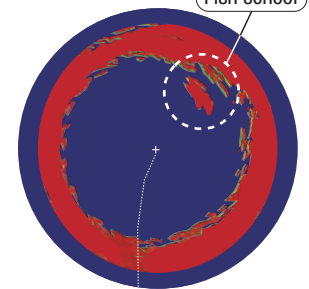
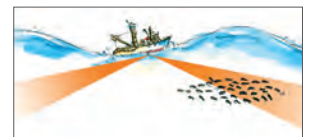

12.1" COLOR LCD DISPLAY SEARCHLIGHT SONAR

Model **CH-600**

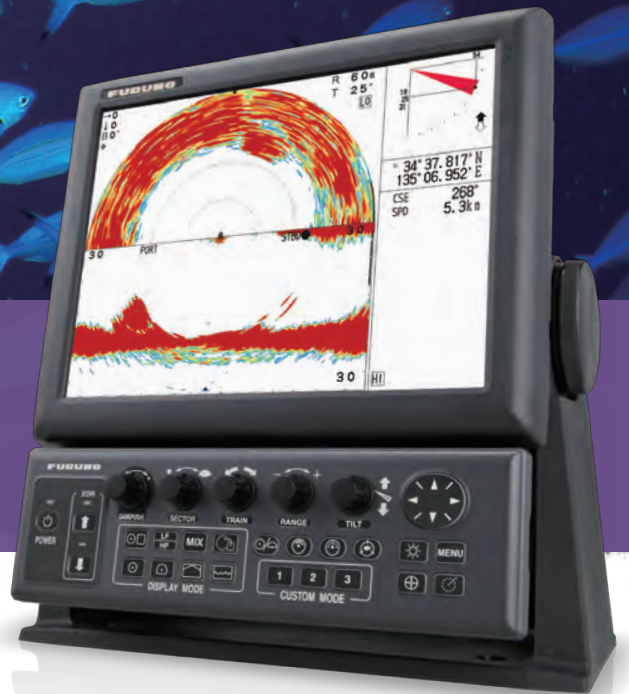

Two frequencies combined to increase your chances of finding fish

The low frequency will serve to cover a wide area horizontally around the ship, while the high frequency can be used in a vertical profile mode to help identify fish school, including their size and their movement.

This information can help in properly deploying a net or steering a better course to reach the targeted school.

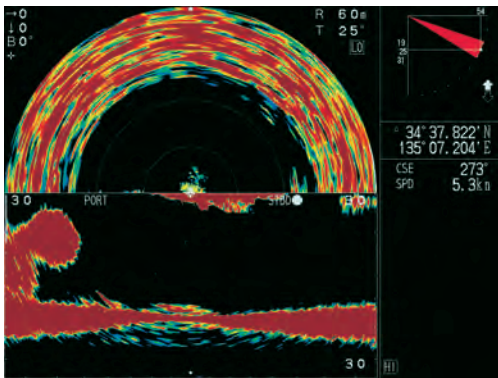

Horizontal and vertical mode (vertical disposition)

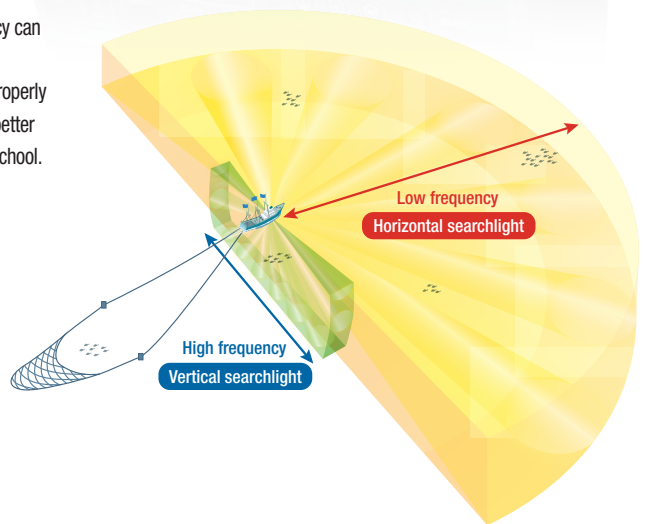

The dual-frequency can reveal the presence of sardines and whitebait

Horizontal mode (Split view)

With the Horizontal dual frequency mode, both low and high frequencies are used and displayed at the same time in split view. By comparing echo shapes at low and high frequency, it becomes possible to ascertain the actual presence of even small fish.

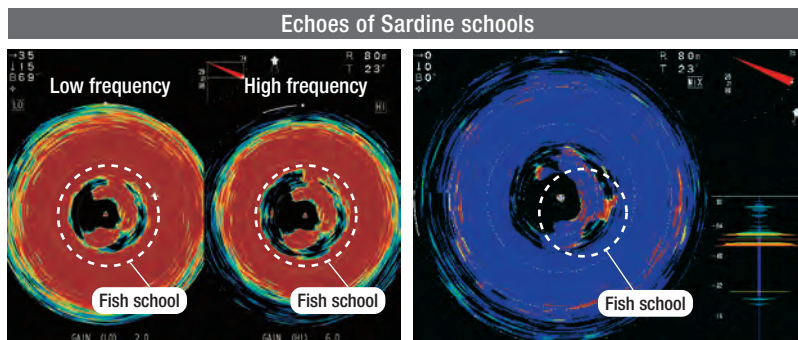

Horizontal Mix display

The CH-600 Mixed mode uses both low and high frequencies to show echoes that matter most to the fisherman. By comparing the two frequencies, or simply overlaying them, it becomes easy to locate and identify whitebait.

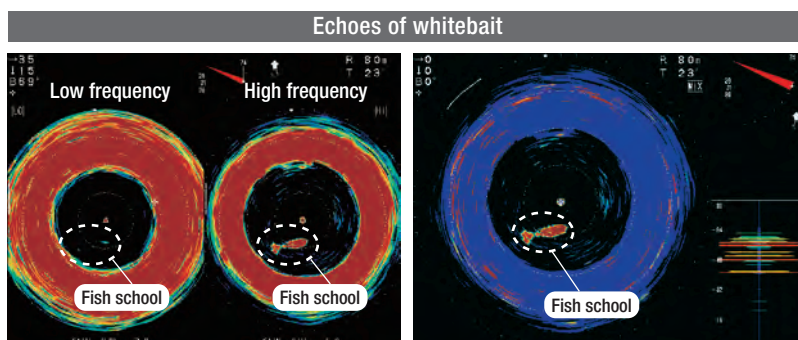

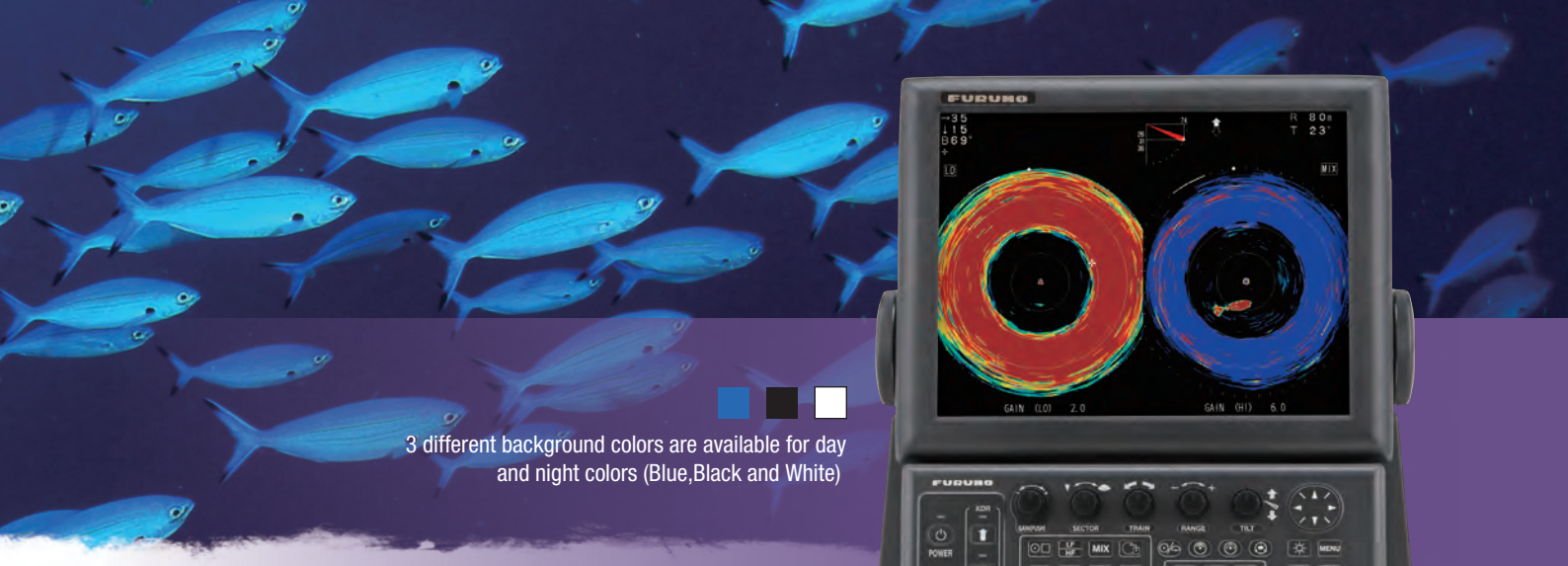

3 different background colors are available for day and night colors (Blue, Black and White)



Higher resolution due to Advanced signal processing

Powerful signal and image processing techniques, based on a unique interpolation technology, provides images in very high resolution. Even if the fish are located near the seabed, the different echoes are clearly shown and easy to understand. The higher resolution display yields a presentation that is crisp and clear.

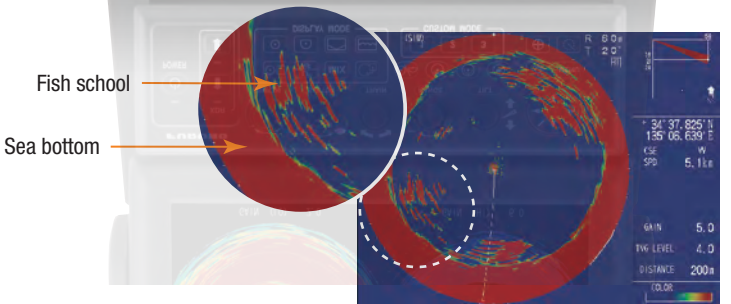

Reverberation reduction

The reverberation reduction offers better understanding and a better appreciation of the nature of detected echoes. Pictures on the right show an example of how the reverberation reduction function highlights the wreck from the surrounding seabed.

*The echo may be subject to interferences from other Fish Finders
 *Schools with excessively high density may appear with a weaker echo color

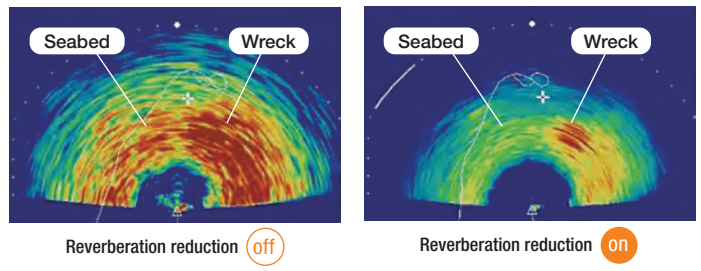

Quick Gain Control

With the CH-600, the value of the changed gain is instantly applied to the whole circle and all echoes are affected, allowing you to quickly react. With the Quick Gain Control, even in deep areas that slow down the scanning speed, there is no need to wait for the next passage of the searchlight and miss precious information. This new function is also extremely valuable if the fish are moving fast and need to be tracked rapidly.

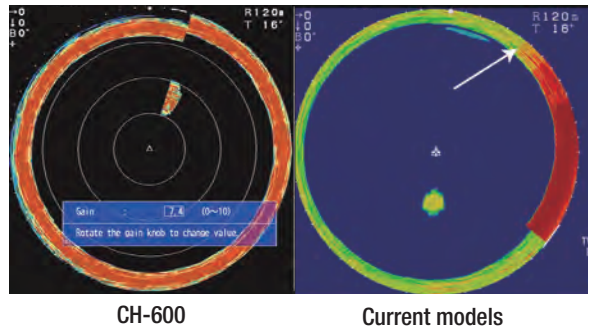

Audible target detection*

The CH-600 also features fish and obstacle audio signals depending on the nature and the size of the detected object. Whether there are air bubbles, fish schools or seabed, and seabed, the emitted sound is unique. It is now easy to differentiate the fish schools from the seabed they are moving next to, allowing for better comprehension of the surrounding environment for more productive fishing. This feature shows its usefulness during long sea trips, as it frees the user from continuously watching the screen.

*Optional Loudspeaker required

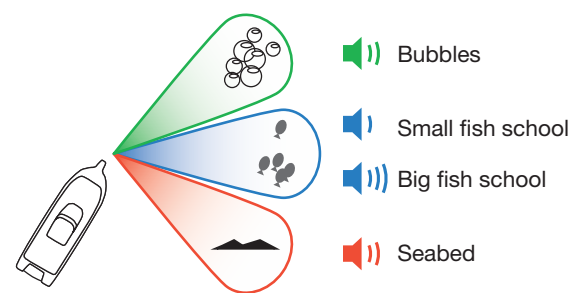
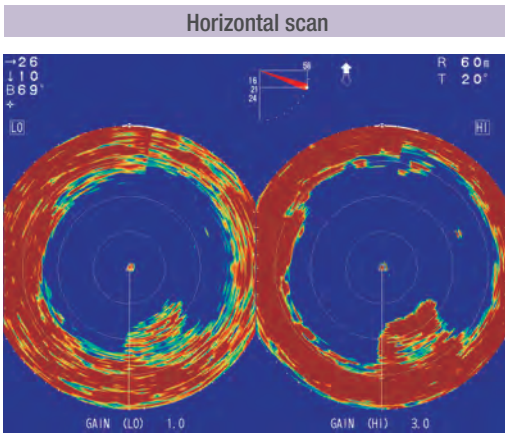

Figure out intuitively what is detected by differentiating their sound with the audible target detection

Display Modes

Various display modes for countless different uses



A full circle scan (360 degree), provided by a rotating transmitter, detects fish schools around the vessel. (Horizontal scan zoom mode also available)

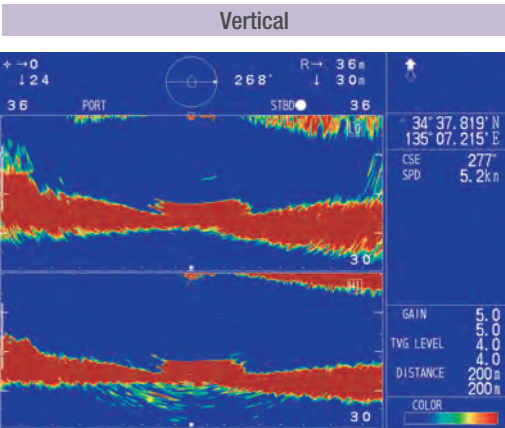

The Vertical scan paints the bottom profile within a user-specified vertical plane in any direction.

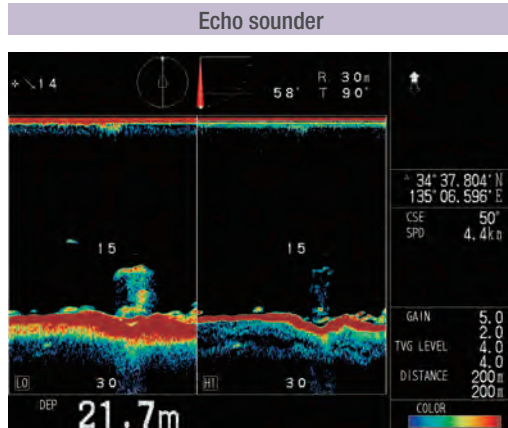

When fully retracted and tilted to 90 degrees, the transducer can detect fish directly below boat quickly.

INTERCONNECTION DIAGRAM

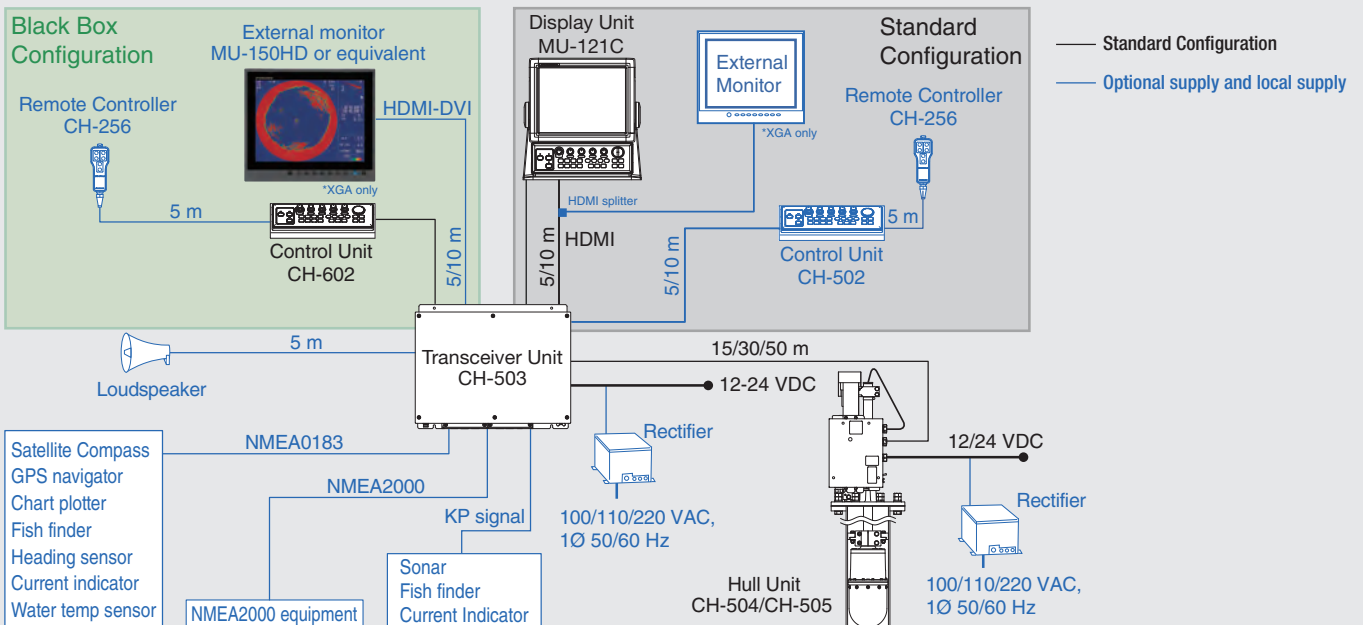

SEARCHLIGHT SONAR SPECIFICATIONS OF Model CH-600

DISPLAY UNIT

Screen type	12.1 inch color LCD, 1024 x 768 (XGA), landscape
Brilliance	0.5 to 950 cd/m ² (selectable)
Echo color	32, 16 or 8 colors (selectable)
	Back-ground: 3 colors (selectable)
Display Mode	1. Horizontal 2. Horizontal (zoomed) 3. Vertical 4. Horizontal and vertical combined 5. Horizontal (zoomed) and vertical combined 6. Full-circle A-Scope 7. Full circle horizontal and full circle A-scope scan combined 8. Full circle horizontal and A-Scope combined 9. Echo sounder 10. Echo sounder and A-Scope combined 11. Horizontal and History combined
	Dual Frequency 12. Dual Horizontal 13. Dual Horizontal Expansion 14. Dual Vertical 15. Dual Echo Sounder 16. Dual Horizontal/History 17. Dual Horizontal/Vertical 18. Dual Horizontal/Vertical Zoomed 19. MIX
Echo information	Range, Sensitivity, TVG, Tilt angle, Interference rejection
Sensor information	L/L (own ship or cursor), Depth, Bearing, Ship's speed, Track, Water current vector, Water temperature (external data required)
Marker	Range and bearing to target
Event mark	5 points
Echo adjustment	Erase color, Clutter, Emphasis mode, Quick gain setting, Auto-filter, Reverberation suppression
Others	Interference rejection, Menu background transparency, Target lock (three functions selected on menu)

TRANSCIVER UNIT

Frequency	60/153 kHz or 85/215 kHz, dual frequency
Output power	1 kW
Pulse length	0.2 to 20.0 ms, according to range (up to 10 ms for each frequency in dual-frequency transmission)
TVG	Level 100 dB max, Distance: 1000 m max.
Range	Horizontal 10 to 2400 m, 15 steps (user selectable) Vertical 10 to 600 m, 15 steps (user selectable)
Audio output	2 W (8 ohms), Freq. 0.9 to 1.2 kHz (optional speaker required)

HULL UNIT

Transducer travel	400 mm (CH-5041) or 250 mm (CH-5051)
Tank size (inner dia.)	200 mm, 8-inch
Raise/lower time	30 s at 400 mm travel, 20 s at 250 mm travel
Ship's bow setting	Setting offset on menu at installation
Horizontal mode control	Scanning angle 6° to 360°, 24° step Scanning speed (step angle) 6°, 12°, 15°, 18°, 21°, 24° Tilt angle -5° to +90° (vertical), 1° step Auto tilt setting ±2° to ±10°
Vertical mode control	Scanning angle 6° to 180°, 12° step Scanning speed (step-angle) Normal: 3°, High speed: 6°
Transceiver beam with (Frequency -3 dB/-6 dB)	60 kHz : horizontal : 16°/22° vertical : 14°/20° 153 kHz : horizontal : 7°/9° vertical : 5°/8° 85 kHz : horizontal : 11°/15° vertical : 10°/15° 215 kHz : horizontal : 5°/6° vertical : 4°/6°
Allowable ship's speed	20 kn or less (15 kn during raise/lower operation)
Stabilization	Built-in motion sensor (standard supply)

INTERFACE

Number of ports	Video signal output: 1 port, HDMI, XGA NMEA0183 (IEC61162-1): 2 ports, V1.5/2.0/3.0/4.0/4.1, 4800/9600/19200/38400 bps NMEA2000: 1 port External KP: 1 port, I/O
Data sentences	Input : CUR, DBS, DBT, DPT, GGA, GLL, GNS, HDG, HDM, HDT, MDA, MTW, RMC, VHW, VTG, ZDA Output : TLL PFEC: pidat
Output proprietary sentence	Input : 059392/904, 060160/416/928, 061184, 065240, 126208/720/992/996, 127250, 128259267, 129025/026/029/033/291, 130310/311/312/316/577/821
NMEA2000 PGN	Output : 059392/904, 060928, 061184, 126208/464/720, 126993/996/998, 130822/823/828 TLL

POWER SUPPLY

Display/Control/Transceiver unit	12-24 VDC: 4.7-2.3 A
Hull unit	12/24 VDC: 2.2/1.1 A (7.2/3.6 A: During raising)
Rectifier	100/110/115/220/230 VAC, 1 phase, 50/60 Hz, 13 A max.

Beware of similar products

All brand and product names are registered trademarks, trademarks or service marks of their respective holders.

ENVIRONMENTAL CONDITION

Ambient temperature	Display/ Transceiver/ Control unit -15°C to +55°C Hull unit 0°C to +55°C (Transducer: 0 to +35°C)
Relative humidity	95% or less at +40°C
Degree of protection	Display/Control unit IP55 Transceiver/Hull unit IP22
Vibration	IEC60945 Ed.4

EQUIPMENT LIST

Standard

Display Unit	MU-121C
Control Unit	CH-602
Transceiver Unit	CH-503
Hull Unit*	CH-504 (400 mm transducer travel) CH-505 (250 mm transducer travel)

Installation Materials and Spare Parts

*Depending on the selected configuration

Option

Remote Controller	CH-256
Rectifier Unit	RU-1746B-2
Control Unit	CH-602
Loudspeaker	CA-151S-ASSY
Display Unit installation kit, Installation kit, Cable, Mounting Bracket, Retraction tank	

Display Unit/Control Unit

MU-121C
4.0 kg 9 lb

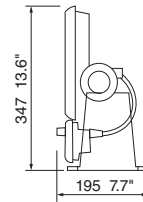
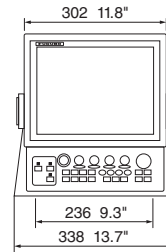

Transceiver Unit

CH-503
3.3 kg 7.2 lb

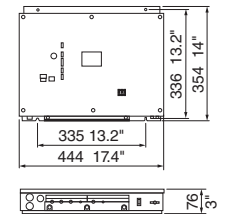

Control Unit (TABLETOP MOUNT)

CH-602
1.3kg 2.9 lb

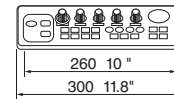

Hull Unit

CH-504 (400 mm Travel) :
41 kg 90 lb

CH-505 (250 mm Travel) :
40 kg 88 lb

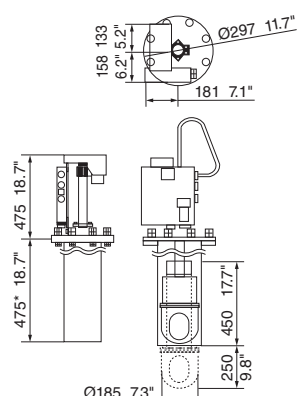
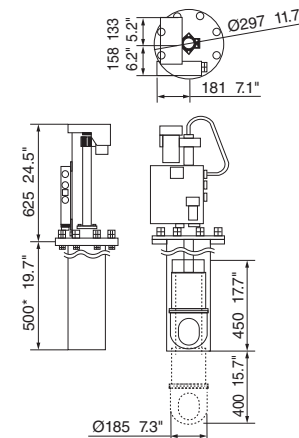

*Minimum Length

SPECIFICATIONS SUBJECT TO CHANGE WITHOUT NOTICE

FURUNO ELECTRIC CO., LTD.

Japan | www.furuno.com

FURUNO U.S.A., INC.

U.S.A. | www.furunousa.com

FURUNO PANAMA S.A.

Republic of Panama | www.furuno.com.pa

FURUNO (UK) LIMITED

U.K. | www.furuno.co.uk

FURUNO NORGE A/S

Norway | www.furuno.no

FURUNO DANMARK A/S

Denmark | www.furuno.dk

FURUNO SVERIGE AB

Sweden | www.furuno.se

FURUNO FINLAND OY

Finland | www.furuno.fi

FURUNO POLSKA Sp. z o.o.

Poland | www.furuno.pl

FURUNO DEUTSCHLAND GmbH

Germany | www.furuno.de

FURUNO FRANCE S.A.S.

France | www.furuno.fr

FURUNO ESPAÑA S.A.

Spain | www.furuno.es

FURUNO ITALIA S.R.L.

Italy | www.furuno.it

FURUNO HELLAS S.A.

Greece | www.furuno.gr

FURUNO (CYPRUS) LTD

Cyprus | www.furuno.com.cy

FURUNO EURUS LLC

Russian Federation | www.furuno.ru

FURUNO SHANGHAI CO., LTD.

China | www.furuno.com/cn

FURUNO CHINA CO., LTD.

Hong Kong | www.furuno.com/cn

FURUNO SINGAPORE

Singapore | www.furuno.sg

PT FURUNO ELECTRIC INDONESIA

Indonesia | www.furuno.id

1-B-1803PDF

Catalogue No. CA000001242