

FURUNO

Stabilized FISH SIZE INDICATOR

Model **FCV-38**

*Stable echo presentation in
all sea conditions!*



Photo : 19" Marine Display MU-190HD (Customer supply)



More details on
www.furuno.com



Optimize your fishing operation detection and Split-beam tec

The FCV-38 is a high performance 4 kW fish finder with a 38 kHz transducer using split beam technology that provides excellent depth detection capability. It also contributes to reliable fish size estimation. In addition, it provides accurate information on fish schools and the seabed, even in stormy weather, thanks to a unique beam stabilizer.

Stabilized FISH SIZE INDICATOR

Model **FCV-38**



- | **Multi-directional beam transmission and reception provides simultaneous search and display in a maximum of five directions**
- | **Unique detection capabilities and stable image offered by a built-in motion sensor**
- | **With connection to a SATELLITE COMPASS™, constant stable display of echoes is achievable with the use of the heave offset function**
- | **Fish size graph (max. 3) allows estimation of fish distribution at a glance**
- | **Target graph allows tracking of a designated fish target**



tion with Multi-direction hology

| Capable of output scientific data in netCDF4 format and calibration

| Long range detection in the deep sea, capable of 1,500m depth

| Net sensor information* can be shown on the display

* Compatible models: TE-155 (Marport), TS-337A (Imaginex) and TI System (Simrad)

**| Hardness and roughness graph allows monitoring of the seabed
hardness and roughness**

| Scroll-back mode allows the user to review past data

**| Data recording and screenshot function allow easy review of past echoes
and recordings**



Echo images from 5 different directions received simultaneously with the multi-beam system

The FCV-38 can detect school of fish in five directions at once and provides information on the location of the targeted fish in relation to the vessel. The operator can adjust the five beams in any direction within a 20 degree range in the menu settings.

For five beam transmission, you can freely activate or deactivate simultaneous transmission and adapt it to your needs by using three types of split-beam mode* in the setting menu: Alternating transmission, Semi-simultaneous and simultaneous transmission.

Semi-simultaneous transmission is new function which limits beam-to-beam interference and makes the seabed easier to identify than with the simultaneous beam transmission mode.

The timing of the transmission has been optimized to accelerate the transmission cycle of the beam even with 5 beams.

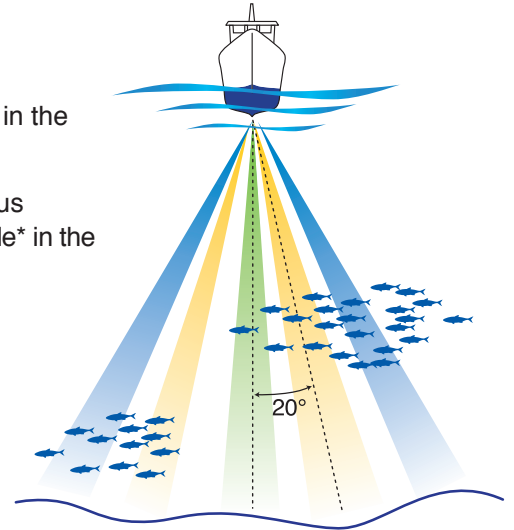

*The screen is drawn faster in this mode, however unwanted echoes (false seabed echoes) may appear.

Alternating transmission

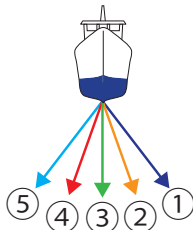

Five beams are alternately transmitted

Menu setting: **Off**

New Semi-simultaneous transmission

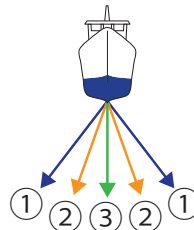

Some beams are simultaneously transmitted

Menu setting: **Auto**

Simultaneous transmission

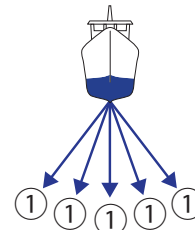

Five beams are transmitted in succession

Menu setting: **On**



Built-in motion sensor provides a stabilized target presentation in rough sea conditions

Pitching and rolling compensation

Pitching and rolling produces adverse effect not only on the sounding image, but also on measurement of fish size. With FURUNO exclusive Stabilizer Technology, the FCV-38 can stabilize both TX and RX beams independently so that the picture will remain accurate.



Stabilizer keeps the beam on the designated target.

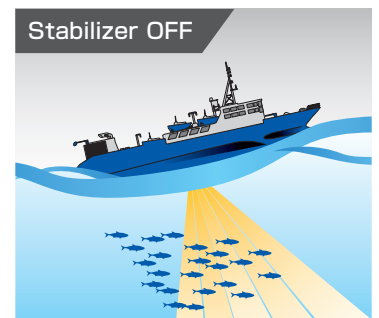

A beam affected by pitching and rolling fails to detect the target fish.

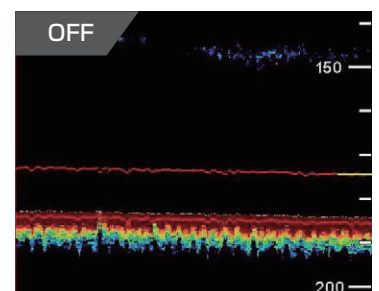
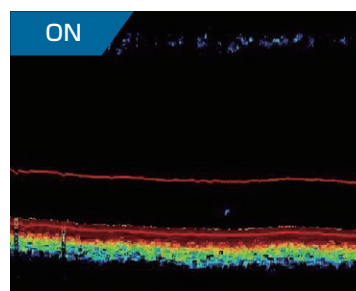



Accurate fish size measurements in easy-to-understand graph form*



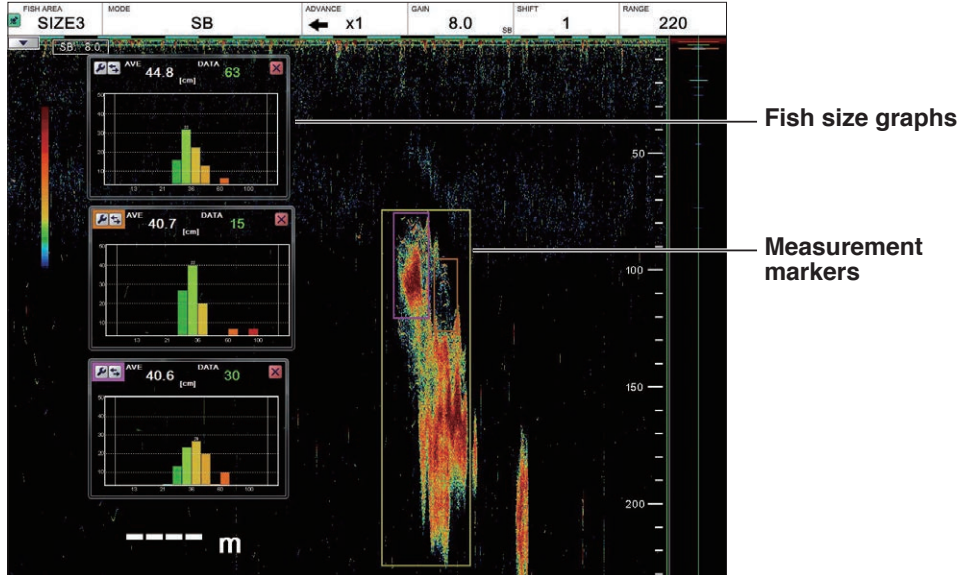

The FCV-38 measures the size of fish in the selected area, and displays the information in a graph that can be understood at a glance. The split-beam technology has improved the accuracy and reliability of fish size measurements and graphs (max. 3).

By analyzing the size, volume and movement of a targeted school of fish, operators can easily decide what to catch and what not to catch. It is indispensable for deciding when to go for a catch and eliminate a school of fish that are smaller than desired. In addition, it greatly contributes to the management and study of fisheries resources.

* Fish length is a reference value calculated from reflection intensity.



FCV-38 has four methods of fish size measurement. You can select your favorite measurement method from InstantAccess bar™ by just clicking on the menu button.

-  [Entire Area] Measure of all detected fish
-  [Specific Range] Measures the detected fish within a specific depth
-  [Bottom Trace] Measures the detected fish near the bottom
-  [Specific Area] Measures the detected fish within the area specified

The fish size measurement function includes particularly useful tools to help the user keep track of targets. For example, the tool [Auto Depth] automatically adjusts the depth of the measurement area until more fish are detected if the target fish has fallen below the set limit or has left the measurement area. The tool [Auto Area] can be used to automatically move and adjust the measurement area to areas with a large number of single fish.

Fish size graph

The fish size graph shows fish size within a user-selected measuring area. The bar graph shows size and proportion of fish in the measuring area selected.

Overall average size of fish detected.

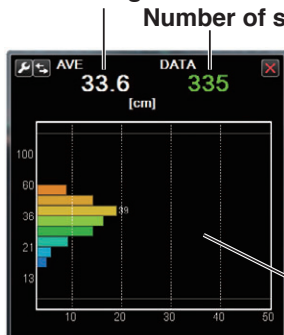

Fish size graph window

The graph shows both the peak fish size (the size of the largest fish) and the average size of the fish in the measurement area, which is useful for estimating the abundance and quality of fish in the target school.

First peak

Estimated fish length which occupies the highest percentage in the measurement area.

Target graphs

The target graphs plot, within a circle representing the target measurement range, the locations of individual fish in relation to your vessel. Two types of graphs, vertical and horizontal are available.



Vertical graph

Own Ship icon



Zoom Modes

Zoom displays enlarge the specified area of the split-beam display. This mode allows you to learn more about the sea floor and the density of schools of fish. The four modes are bottom lock, bottom zoom, marker zoom, and bottom discrimination. The expansion range is available from 2m to 200m depth. You can also freely change the window size by dragging and dropping the window frame.

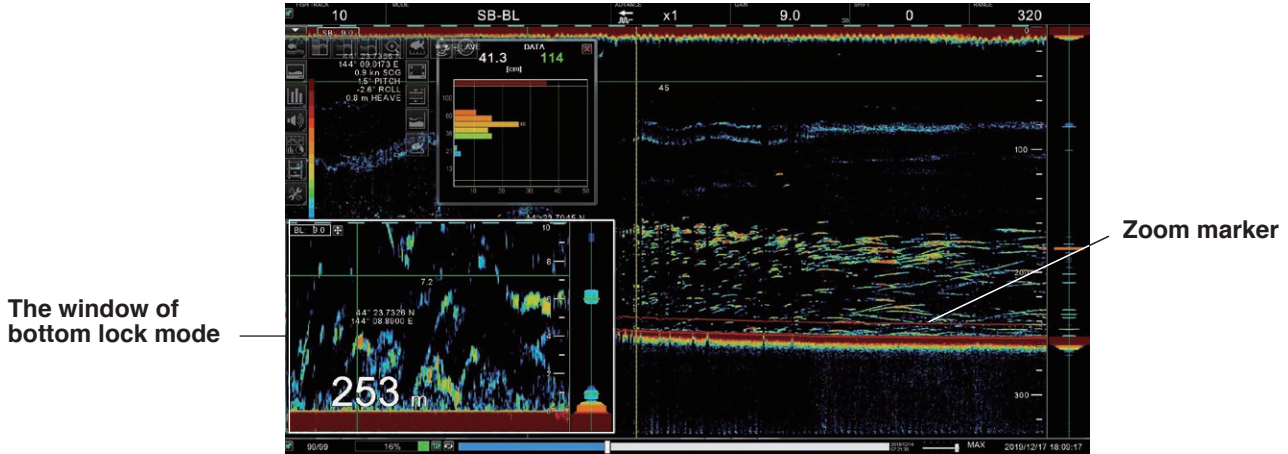

Screenshots and echo data can be recorded and play back

A maximum of 99 screenshots can be saved on the processing unit. You can also replay the echo display at any time if you wish to see it again. This is helpful in comparing the sizes of schools of fish. For external memory devices*, the number of files that can be saved depends on the capacity of the device.



scroll back mode* allows you to view past screens of fish finder images, making it handy for comparing the sizes of schools of fish close to each other.

* All echoes stop when the scroll back mode is activated.



Easy and quick operation

The FCV-38 can be operated easily and quickly with its trackball. The screen header also contains Range, Shift, Sensitivity, Image Feed, and Display Mode menus that can be immediately accessed when required. Other functions can also be accessed immediately by setting them in the InstantAccess bar™ as desired*.

* Up to 10 icons can be set in the InstantAccess bar™.



Trackball control unit

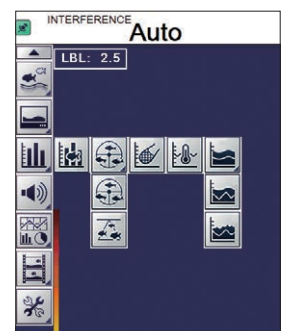

InstantAccess bar™



Scientific data output

The output of scientific data in netCDF4 format will contribute to fish stock assessment etc. Data analysis software that can read data in netCDF format is currently being developed in some institutes*.

*We recommend to check with the nearest dealer

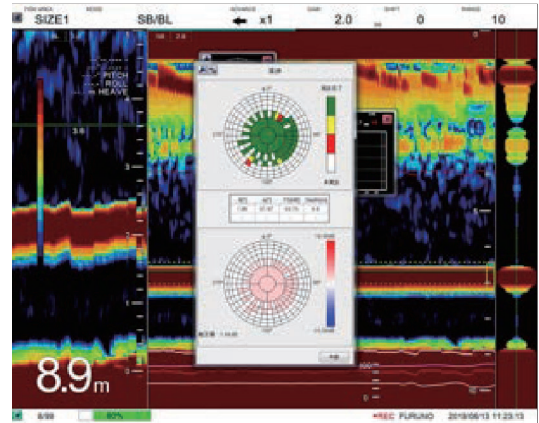

Calibration

Calibration is mandatory for acoustic resource surveys. Thanks to a more accurate calibration function and an improved user interface, you can easily check the status of the data acquisition. In addition, the detection zone, its progress and completion can be viewed at a glance on the calibration screen.

SYSTEM CONFIGURATION

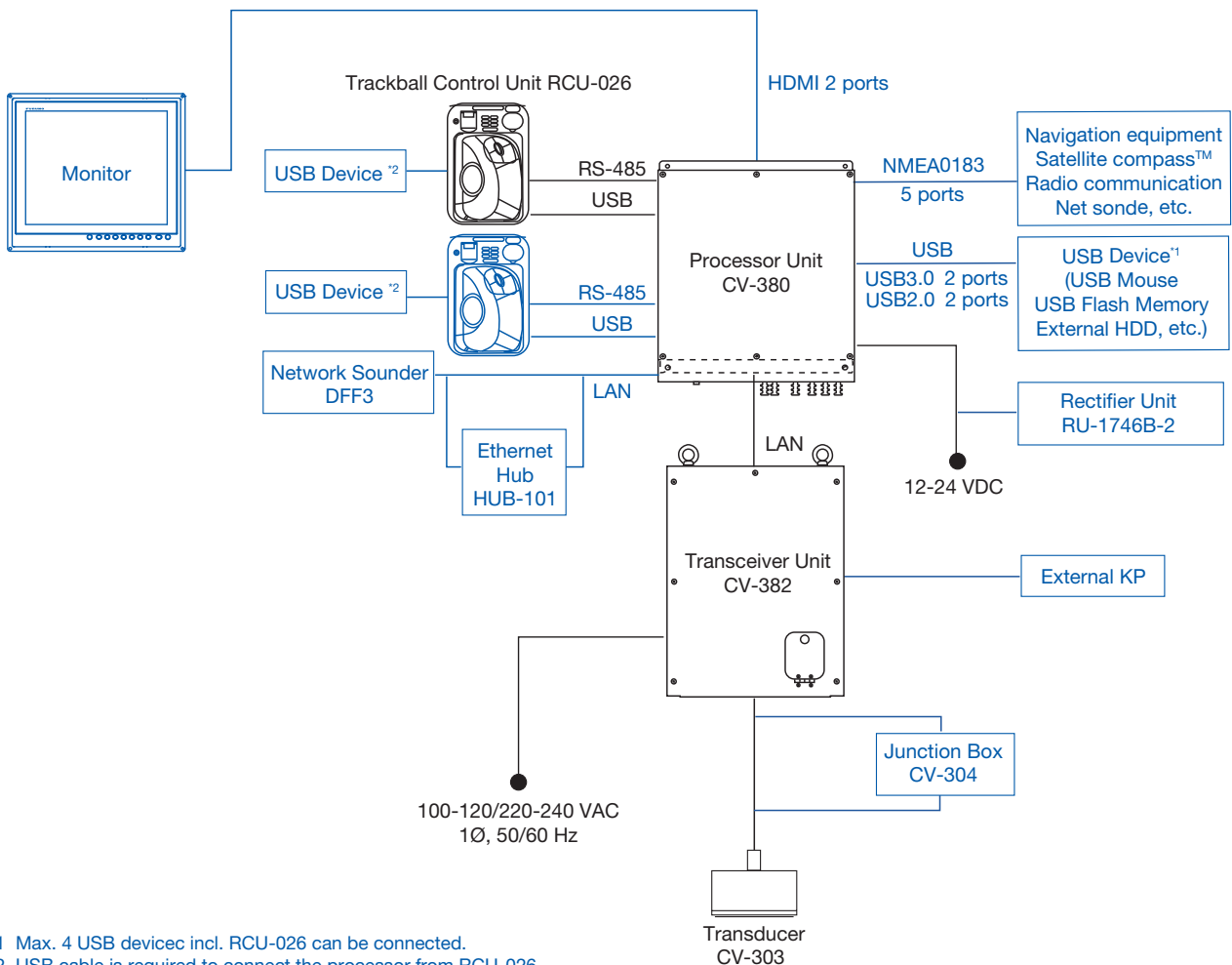

*1 Max. 4 USB devices incl. RCU-026 can be connected.
 *2 USB cable is required to connect the processor from RCU-026
 To extend the cable from Processor, please use the optional DV/USB repeater.

———— Standard
 ———— Optional or local supply

Stabilized FISH SIZE INDICATOR

Model **FCV-38**

GENERAL

Transmitting frequency 38 kHz
 Output power 4 kW
 Number of channel 64 ch
 Transmitting mode CW/FM
 Transmit rate 1200 pulse/min.max.
 Beam control range Bow/stern, port/stdb within 20°

PROCESSOR UNIT

Display range 10 to 3000 m
 Range shift 2000 m max.
 Expansion range 2 to 200 m
 Display mode Single, Multi-beam combination, Zoom, External fish finder combination
 Zoom display Bottom zoom, Bottom lock expansion, Marker zoom, Discrimination zoom
 Advance speed Freeze, 1/16, 1/8, 1/4, 1/2, 1/1, 2/1, 4/1, 8/1 (Lines/TX)
 Fish size histogram Display three points simultaneously
 Alarm Bottom, Fish, Bottom fish, Water temperature, Fish size histogram
 Language English (UK/US), Japanese
 Display function (commercial monitor required)
 Resolution 1920 x 1200 (WUXGA), 1920 x 1080 (FHD), 1600 x 1200 (UXGA), 1024 x 1280 (SXGA), 1024 x 768 (XGA)
 Video output 2 ports, HDMI (Type-A)
 Colors 64/16 (Echo)

INTERFACE

Number of ports of Processor Unit
 Serial 5 ports, NMEA0183 Ver.1.5/2.0/3.0
 LAN 2 ports (for transceiver unit, external sounder/maintenance)
 Ethernet, 10/100/1000Base-T
 USB USB2.0: 2 ports, USB3.0: 2 ports.
 Data Sentences GGA, GLL, GNS, MTW, VHW, VTG, ZDA, GPatt, GPPhve, pirq, IIDAD, IIDBS, IIFHB, IIMTW, IITPC, IITPT, MPMSD, pirq, SDDBS, SDFnz
 Output DBS, DBT, DPT, MTW, TLL, SDbhr, SDFlg, SDmrk, pidat

POWER SUPPLY

Processor unit 12-24 VDC, 4.0-2.0 A
 Transceiver unit 100-120/200-240 VAC: 5 A max, 1 phase, 50/60 Hz

ENVIRONMENTAL CONDITIONS

Ambient temperature

Processor unit -15°C to +55°C (storage: -15°C to +70°C)
 Transceiver unit -10°C to +45°C (storage: -15°C to +70°C)
 Control unit/Junction box -15°C to +55°C
 Transducer -5°C to +35°C
 Relative humidity 93% or less at +40°C

Degree of protection

Processor/Transceiver unit IP22
 Control unit IP22 (IPx0 w/o USB port cover)
 Junction box IP20
 Transducer IPX8
 Vibration IEC60945 Ed.4

EQUIPMENT LIST

Standard

- 1.Processor Unit CV-380 1 unit
- 2.Transceiver Unit CV-382 1 unit
- 3.Trackball Control Unit RCU-026 1 unit
- 4.Transducer CV-303 1 unit
- 5.Thru-Hull Pipe TFB-1600 1 unit
- 6.Installation Materials 1 set

Option

- 1.Junction Box CV-304-10/20/50 (with 10/20/50 m cable)
- 2.Rectifier Unit RU-1746B-210 or AC/DC Power Supply Unit PR-241
- 3.HDMI cable for Processor Unit-Display Unit (10.3/5.3 m)
- 4.Cable Assembly for Trackball Control Unit
- 5.LAN Cable for DVI/USB repeater (30/50/100 m)
- 6.Flush Mount for Trackball Control Unit
- 7.Transducer Fixing Kit
- 8.Installation Materials

Processor Unit (Blukhead/Tabletop Mount) CV-380

7.6 kg 16.8 lb

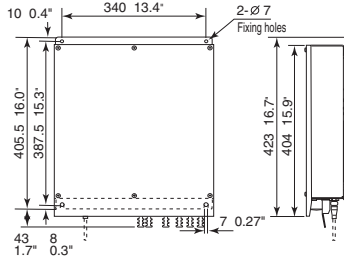

Trackball Control Unit RCU-026

Tabletop Mount 1.4 kg 3.1 lb

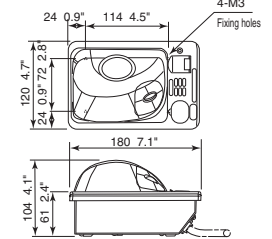

Transceiver Unit (Floor mount) CV-382

33 kg 72.8 lb

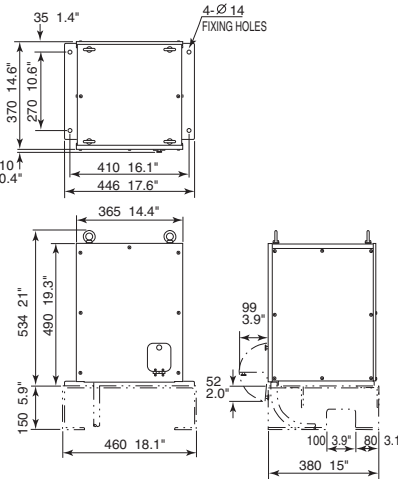

Fixture Mount

1.5 kg 3.3 lb

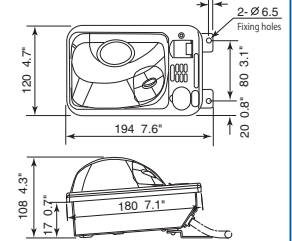

Flush Mount

1.5 kg 3.3 lb

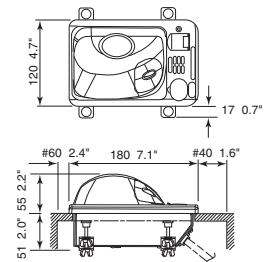

Junction Box (Blukhead Mount) CV-304

1.6 kg 3.5 lb

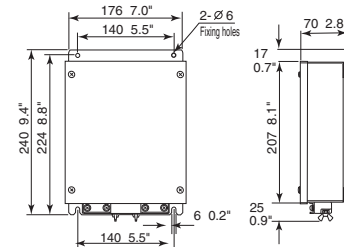

TRANSDUCER CV-303

40 kg 88.2 lb

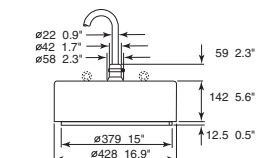

Beware of similar products

All brand and product names are registered trademarks, trademarks or service marks of their respective holders.

SPECIFICATIONS SUBJECT TO CHANGE WITHOUT NOTICE

FURUNO ELECTRIC CO., LTD.
Japan | www.furuno.com

FURUNO U.S.A., INC.
U.S.A. | www.furunousa.com

FURUNO PANAMA S.A.
Republic of Panama | www.furuno.com.pa

FURUNO (UK) LIMITED
U.K. | www.furuno.co.uk

FURUNO NORGE A/S
Norway | www.furuno.no

FURUNO DANMARK A/S
Denmark | www.furuno.dk

FURUNO SVERIGE AB
Sweden | www.furuno.se

FURUNO FINLAND OY
Finland | www.furuno.fi

FURUNO POLSKA Sp. Z o.o.
Poland | www.furuno.pl

FURUNO DEUTSCHLAND GmbH
Germany | www.furuno.de

FURUNO FRANCE S.A.S.
France | www.furuno.fr

FURUNO ESPAÑA S.A.
Spain | www.furuno.es

FURUNO ITALIA S.R.L.
Italy | www.furuno.it

FURUNO HELLAS S.A.
Greece | www.furuno.gr

FURUNO (CYPRUS) LTD
Cyprus | www.furuno.com.cy

FURUNO EURUS LLC
Russian Federation | www.furuno.ru

FURUNO SHANGHAI CO., LTD.
China | www.furuno.com/cn

FURUNO CHINA CO., LTD.
Hong Kong | www.furuno.com/cn

FURUNO SINGAPORE
Singapore | www.furuno.sg

PT FURUNO ELECTRIC INDONESIA
Indonesia | www.furuno.id

FURUNO ELECTRIC (MALAYSIA) SDN. BHD.
Malaysia | www.furuno.com/my