

**FURUNO**

**TruEcho CHIRP WITH UNIQUE  
FISH SIZE INDICATOR**

Model

***FCV-1900G***

*High precision fish size graph  
for **efficient and sustainable fishing***

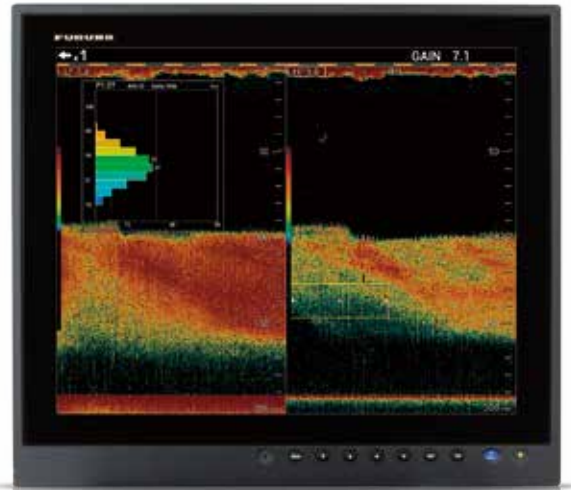

Photo: 19" Marine Display MU-190HD (Customer Supply)

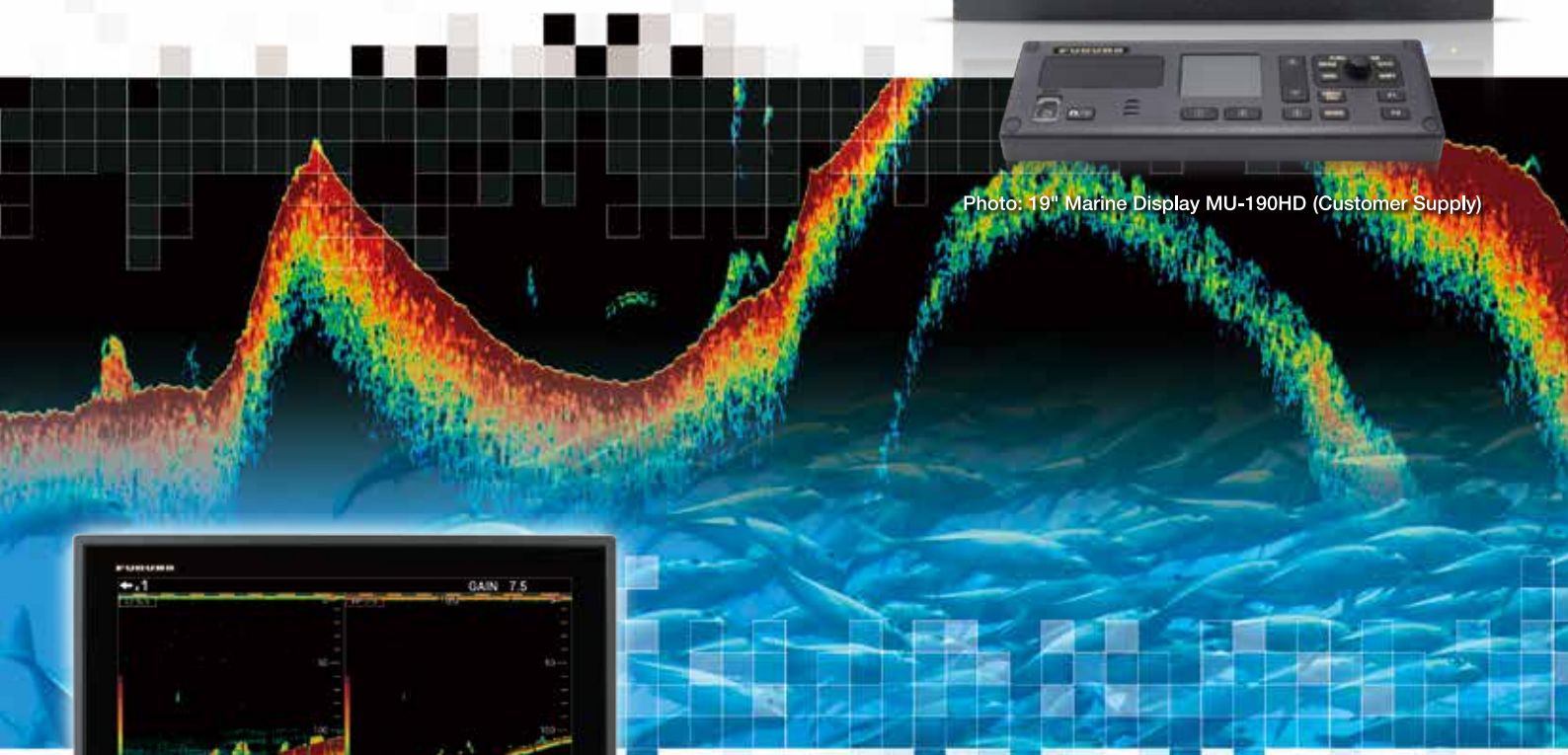

Photo: 19" Marine Display MU-190HD (Customer Supply)

Model

**HI-RES TruEcho CHIRP FISH FINDER**  
***FCV-1900B***

*High resolution echoes  
from shallow to deep waters*



[www.furuno.com](http://www.furuno.com)



## Upgrade your FCV-1900

By purchasing and installing a software license a FCV-1900B Hi-Res TruEcho CHIRP Fish Finder Fish Size Indicator. For further details, please contact your dealer.

# HI-RES TruEcho CHIRP FISH FINDER FCV-1900B

Model

## High resolution echoes from shallow to deep waters made possible with TruEcho CHIRP™ technology



FCV-1900B Hi-Res TruEcho CHIRP Fish Finder allows you to see echoes that would otherwise not have been visible.

### Sea bottom

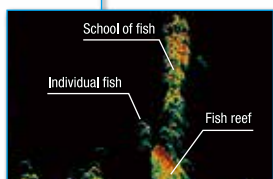
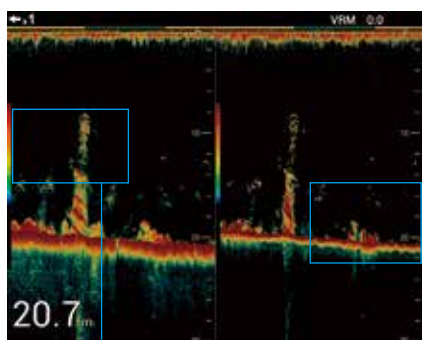

Individual fish can be discriminated within schools of fish, for easy identification of size and species.

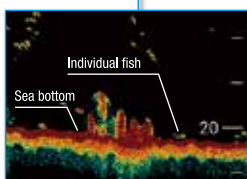

You can easily spot individual fish close to the sea bottom

### Individual fish

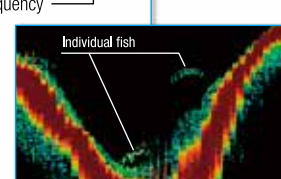
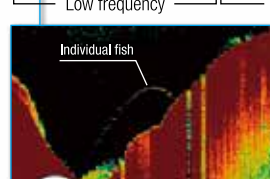
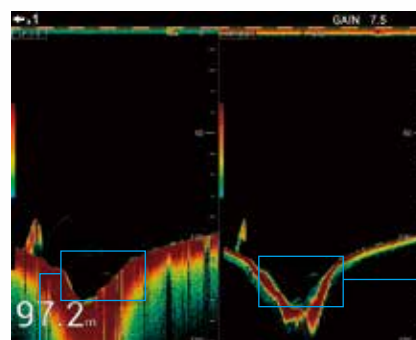

With improved depth resolution, individual fish can be observed even at depths of 100 m and deeper. Fish are displayed in a distinct boomerang shape.

### Near the surface

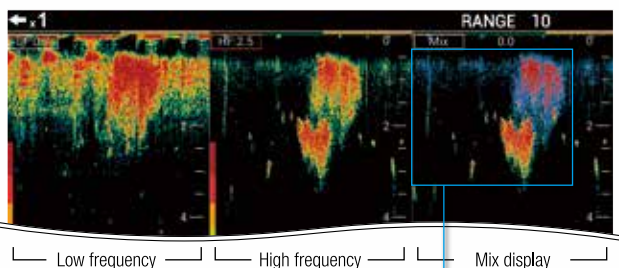

Fish are displayed clearly, even when it is close to the sea surface. In the mix display, bubbles are displayed in blue, and fish are displayed in bright red for easy target discrimination.  
(Recommended transducer: CM275LHW)

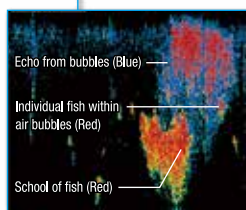

### Middle layer

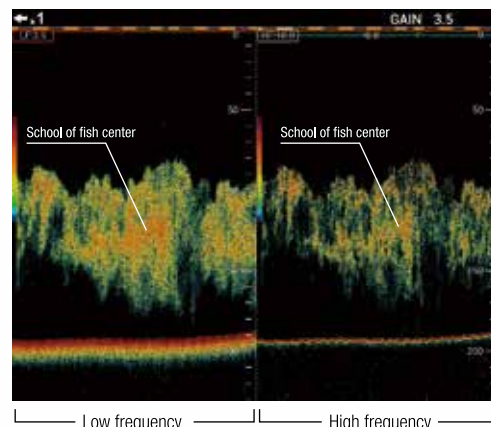

Spot the center of a school of fish simply by observing the color. Dense echoes are displayed in darker colors.

# Fish Finder

You can upgrade your FCV-1900 Fish Finder to a FCV-1900G TruEcho CHIRP with unique fish size indicator. Contact your local FURUNO national distributor.

## TruEcho CHIRP WITH UNIQUE FISH SIZE INDICATOR

Model

# FCV-1900G



## Efficient and sustainable fishing with fish size graph functionality

FCV-1900G features a unique fish size indicator that utilizes TruEcho CHIRP™ technology for precise estimations of fish size and size distribution in schools of fish. You can accurately analyze schools of fish all the way from shallow to deep waters.

### Identify size and distribution with the fish size graph for increased efficiency at sea

With a quick glance at the simple and efficient graph, you can get all the information you need to identify fish size and distribution. Once you know the fish size and its distribution, you can use this information to estimate the species and whether it's a viable target or not. Together with the TruEcho CHIRP™ technology, the FCV-1900G allows you to choose the best position to throw your net. Then, based on the fish size graph, you can choose the right mesh size for efficient operation.

(Recommended transducers: CM265LH or CM599LH)

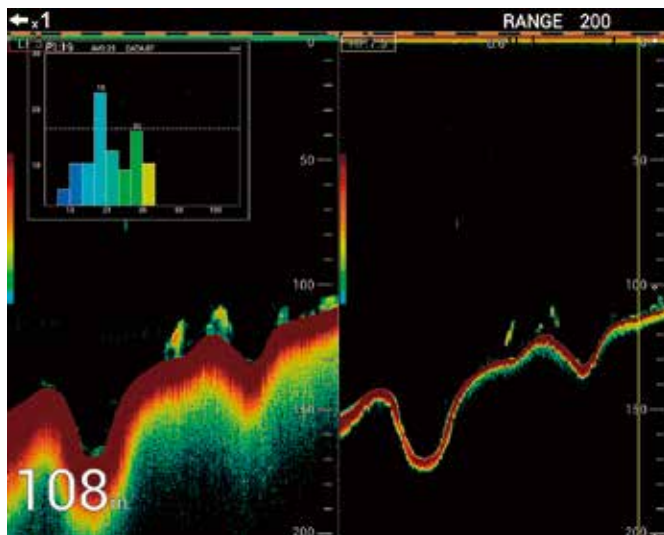
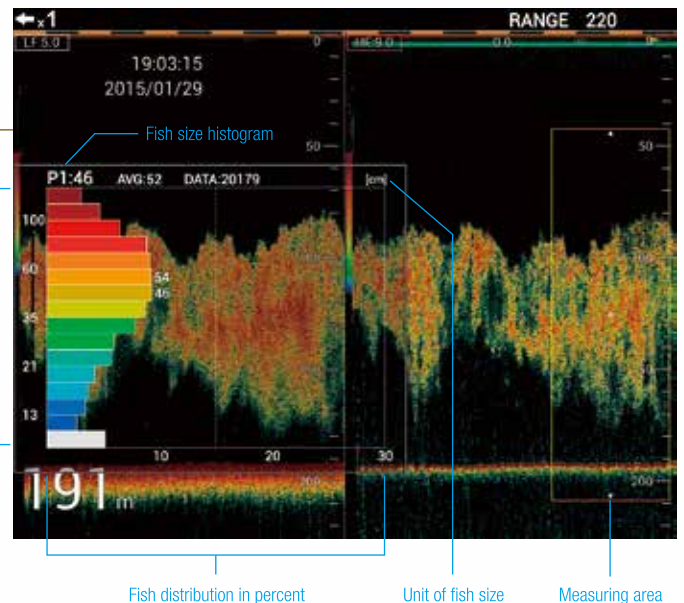

School of fish close to the sea bottom.

### Accurately judge which target to go after

Experience incredibly accurate echoes, even in deep waters thanks to our TruEcho CHIRP™ technology. The FCV-1900G is well suited for trawlers where accurate and reliable information about the sea bottom is necessary. Utilizing the fish size graph, choosing the right target is simple, allowing you to maximize your time at sea, while avoiding unnecessary bycatches.

## SPECIFICATIONS

### 1. GENERAL

- 1.1 **Transmitting frequency** 15 kHz to 200 kHz, Free-synthesize  
 1.2 **Output power** 1, 2 or 3 kWrms  
 1.3 **Transmitting rate** 10 to 2700 pulse/min  
 (5 to 3000 mm range, normal mode)  
 1.4 **Transmitting mode** TruEcho CHIRP™, Standard mode, CW mode  
 1.5 **Pulselength** 0.05 to 5 ms  
 1.6 **External monitor (required specifications)**  
**Display resolution** Landscape XGA (1024x768), SXGA (1280x1024), FHD (1920x1080), Portrait SXGA (1024x1280)

### 2. PROCESSOR UNIT

- 2.1 **Color indication**  
**Echo color** 8, 16 or 64 colors according to echo intensity  
**Background color** Select from 5 colors  
 2.2 **Hue** 7 steps (standard, Hue 1 to 5, customized)  
 2.3 **Echo display mode** Single mode (high/low frequency), Dual-frequency, Zoom, User 1/2  
 User 1/2 available to use mixture, multi-gain, telesounder and external sounder display  
 2.4 **Zoom display** Bottom-lock expansion, Bottom zoom, Marker zoom, Discrimination zoom  
 2.5 **Depth range** 5 to 3000 m  
 2.6 **Range shift** 2000 m max.  
 2.7 **Expansion range** 2 to 200 m  
 2.8 **Fish size histogram (FCV-1900G only)** 2 m depth or more, specified transducer required  
 2.9 **Display advance speed** 6 steps (Lines/TX: Freeze, 1/4, 1/2, 1/1, 2/1, 4/1)  
 2.10 **Data recording** Echo display and measured data can be recorded to internal memory  
 2.11 **Language** Chinese, Danish, English, French, Japanese, Korean, Russian, Spanish, Norwegian

### 3. INTERFACE

- 3.1 **Number of port**  
**NMEA** 3 ports, NMEA V1.5/2.0/3.0  
**LAN** 1 port, Ethernet 100Base-TX (HUB required)  
**CIF** 1 port  
**Net sonde** 1 port, (sonde marker/ sonde KP)  
**Video signal** 1 port, HDMI type-D  
**External KP** 1 port  
**Temperature sensor** 1 port  
**USB** 1 port, USB2.0  
 (specified monitor brilliance control available)  
 3.2 **Data sentences**  
**Input** GGA, GLL, GNS, MTW, VHW, VTG  
**Output** DBS, DBT, DPT, MTW, TLL  
 3.3 **Output proprietary sentences**  
**PFEC** afl, bcd, dat, mrk

### 4. POWER SUPPLY

- 4.1 **Processor unit** 12-24 VDC: 8.3-3.9 A  
**Rectifier (RU-1746B-2, option)** 100/110/115/220/230 VAC, 1 phase, 50/60 Hz  
**AC/DC power supply unit (PR-240, option)** 100-115/200-230 VAC, 1 phase, 50-60 Hz

### 5. ENVIRONMENTAL CONDITIONS

- 5.1 **Ambient temperature** -15°C to +55°C  
 5.2 **Relative humidity** 95% or less at +40°C  
 5.3 **Degree of protection** IP22  
 5.4 **Vibration** IEC 60945 Ed.4

## EQUIPMENT LIST

#### Standard

1. Processor Unit (FCV-1901) ..... x1  
 2. Control Unit (FCV-1902) ..... x1  
 3. Spare parts, Installation materials

#### Option

Transducer, Thru-hull pipe, Interface Unit (FCV-1903), Ethernet HUB, Junction box, Booster box, Temperature sensor, AC/DC power supply unit, Rectifier, Installation material, Cable assembly, Cable (for transducer extension), HDMI-M Cable

## Processor Unit

**FCV-1901**  
 10.2 kg 22.5 lb

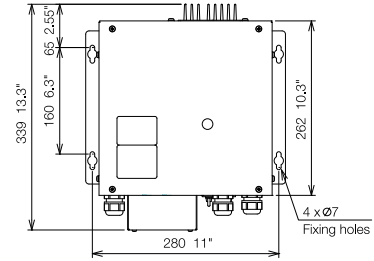

## Control Unit

**FCV-1902**  
 1.1 kg 2.4 lb

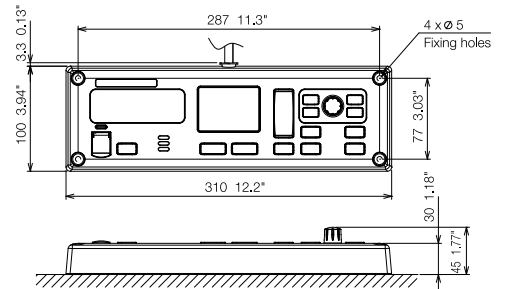

## Interconnection Diagram

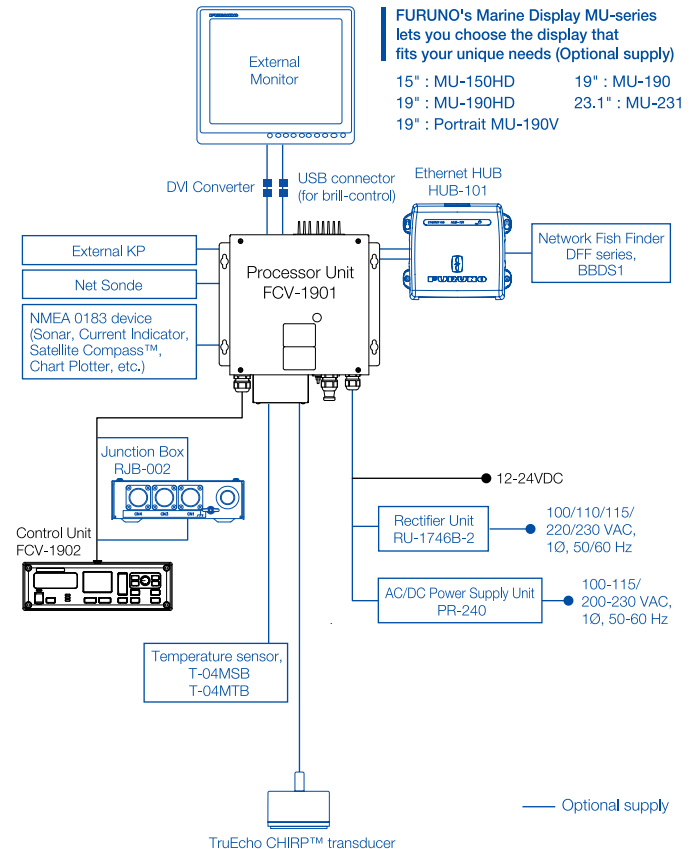

Beware of similar products

All brand and product names are registered trademarks, trademarks or service marks of their respective holders.

SPECIFICATIONS SUBJECT TO CHANGE WITHOUT NOTICE

**FURUNO ELECTRIC CO., LTD.**  
 Japan | www.furuno.com

**FURUNO U.S.A., INC.**  
 U.S.A. | www.furunousa.com

**FURUNO PANAMA S.A.**  
 Republic of Panama | www.furuno.com.pa

**FURUNO (UK) LIMITED**  
 U.K. | www.furuno.co.uk

**FURUNO NORGE A/S**  
 Norway | www.furuno.no

**FURUNO DANMARK A/S**  
 Denmark | www.furuno.dk

**FURUNO SVERIGE AB**  
 Sweden | www.furuno.se

**FURUNO FINLAND OY**  
 Finland | www.furuno.fi

**FURUNO POLSKA Sp. Z o.o.**  
 Poland | www.furuno.pl

**FURUNO DEUTSCHLAND GmbH**  
 Germany | www.furuno.de

**FURUNO FRANCE S.A.S.**  
 France | www.furuno.fr

**FURUNO ESPAÑA S.A.**  
 Spain | www.furuno.es

**FURUNO ITALIA S.R.L.**  
 Italy | www.furuno.it

**FURUNO HELLAS S.A.**  
 Greece | www.furuno.gr

**FURUNO (CYPRUS) LTD**  
 Cyprus | www.furuno.com.cy

**FURUNO EURUS LLC**  
 Russian Federation | www.furuno.ru

**FURUNO SHANGHAI CO., LTD.**  
 China | www.furuno.com/cn

**FURUNO CHINA CO., LTD.**  
 Hong Kong | www.furuno.com/cn

**FURUNO SINGAPORE**  
 Singapore | www.furuno.sg

**PT FURUNO ELECTRIC INDONESIA**  
 Indonesia | www.furuno.id