

**FURUNO**

# Full-Circle Color Scanning Sonar

Model **FSV-85 MARK-2**

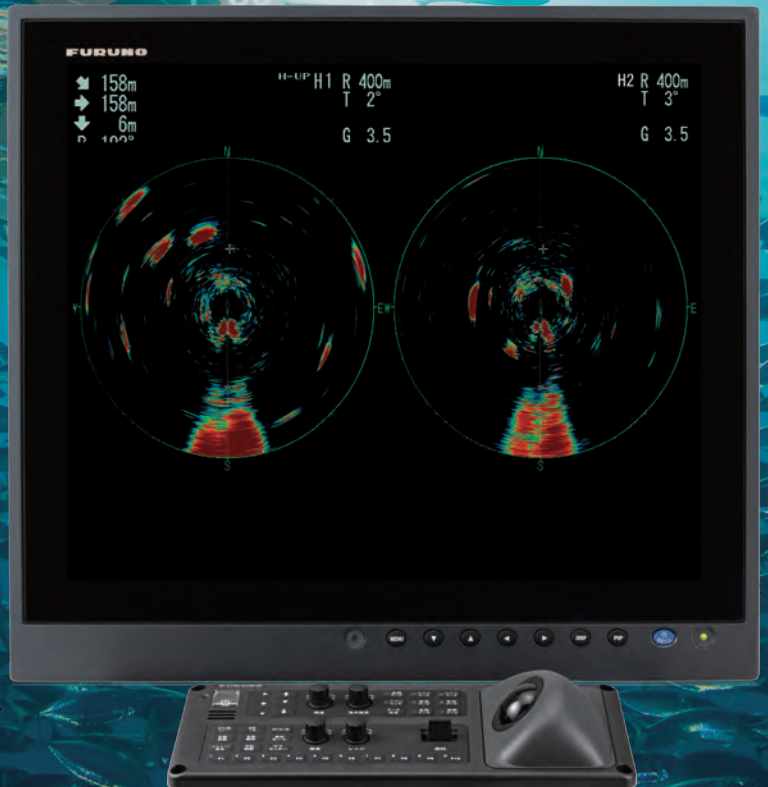

Photo: Optional MU series monitor



# Fishing ground analysis from every po

## Horizontal modes

The horizontal display mode provides a 360 degree picture around the vessel. The H2 mode shows one of four kinds of horizontal display combinations: PORTRAIT, LANDSCAPE, RIGHT INSET and LEFT INSET. The range, tilt, gain and user program are set independently, for each display.

### Portrait

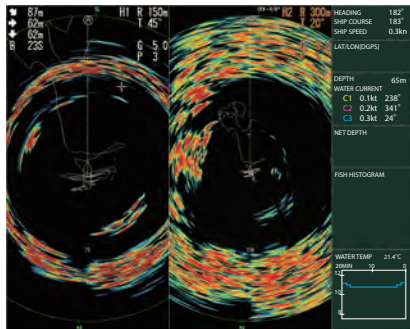

Horizontal1

Range: 150m  
Tilt: 45°  
Gain: 5.0

Horizontal2

Range: 300m  
Tilt: 20°  
Gain: 5.0

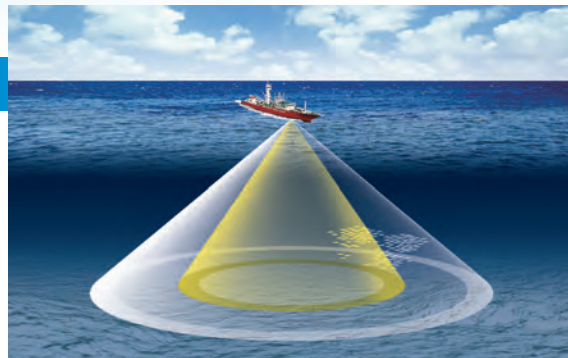

### Portrait

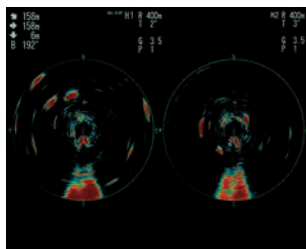

### Landscape

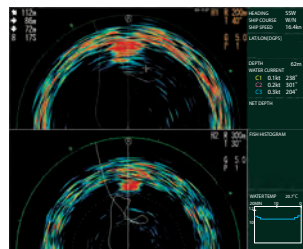

### Right Inset

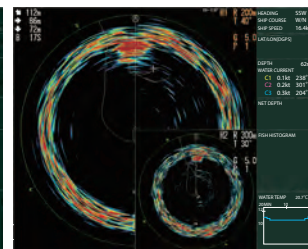

## Slant mode

The slant mode provides a half-circle (180 degrees) picture like half-circle sonar.

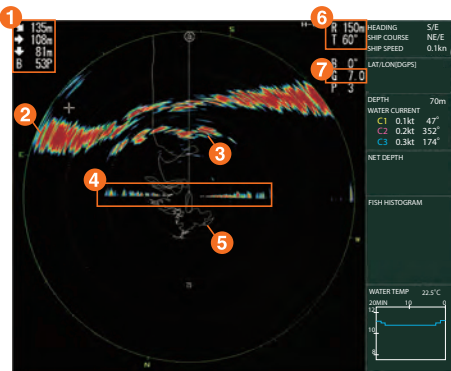

- 1 Direct distance, horizontal distance, water depth and bearing to the cursor
- 2 Seabed
- 3 School of fish
- 4 Sea surface reflection
- 5 Ship's track
- 6 Range, tilt, and display mode of Slant Mode
- 7 Gain

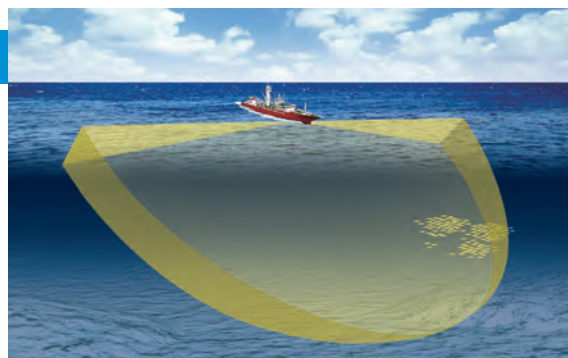

## Horizontal and Vertical Display Combinations

The world's first sonar in its class to combine two vertical sections. The sonar is capable of recording a vertical cross-section (0-90°) in any direction, either in one direction or in two directions. This allows the user to compare two schools of fish at the same time.

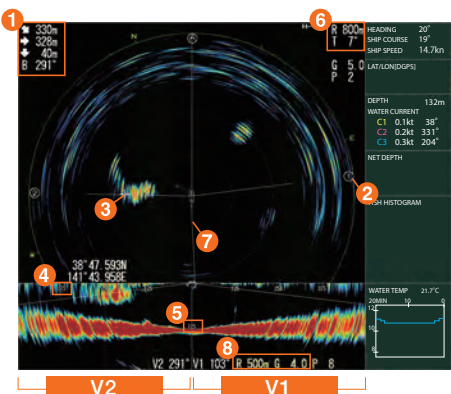

- 1 Direct distance, horizontal distance, water depth and bearing to the cursor
- 2 Bearing mark for vertical mode 1 (V1)
- 3 Cursor
- 4 Range distance of vertical mode
- 5 Water depth under the boat
- 6 Range, tilt, and display mode of Horizontal mode
- 7 Ship's track
- 8 Range and gain of Vertical mode

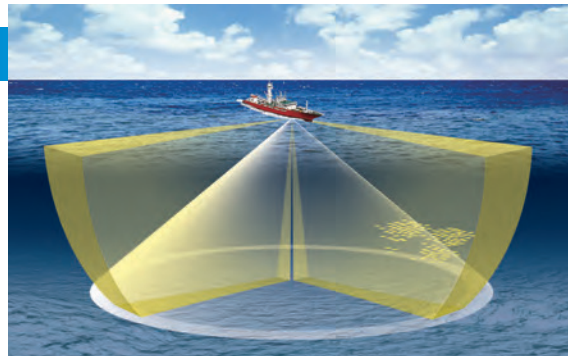

# ossible angle

## ▶ High resolution for long range detection

The combination of highly sensitive sensors and Furuno's new processing technology allows for longer range detection than ever before while maintaining high resolution targets.

## ▶ Target lock function for fish tracking

\*requires vessel speed and heading data

Automatically track schools of fish while calculating their speed and direction. Also display the distance and depth from the vessel to the school.

It is also possible to track a fixed position such as a sea current.

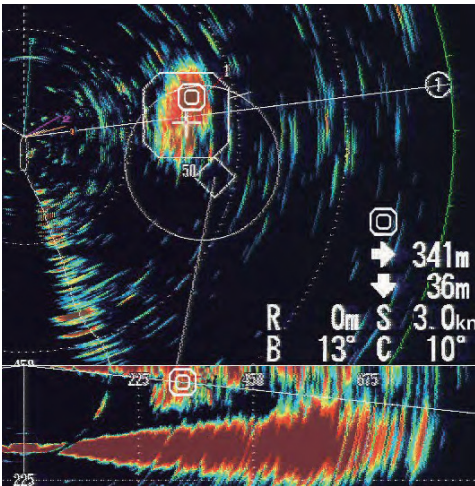

By hitting the target lock mark on a fish school echo, the distance and depth to that school of fish, as well as the direction and speed of movement are displayed numerically.

## ▶ Auto filter for clearer images

The FSV-85-MARK-2 incorporates a digital filter that regulates noise interference, providing a clear view of the display at high speed without affecting the Sonar.

## ▶ Stabilization function

The stabilization function compensates for the effects of pitch and roll. This allows stable detection of sea currents and schools of fish, even in poor weather conditions.

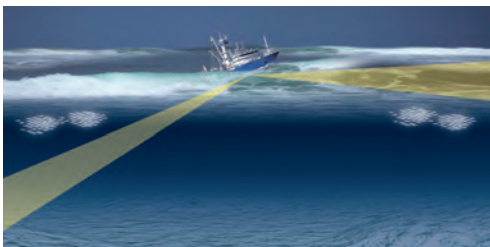

Stabilization function OFF

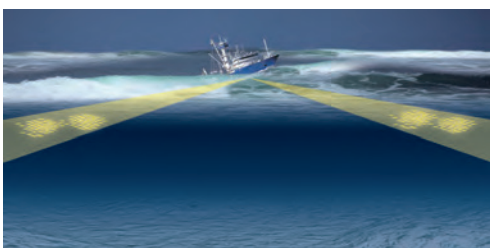

Stabilization function ON

## ▶ Fish concentration and histogram display to help you decide when to cast your net.

In conjunction with the target lock function, the Sonar can display the relative volume of fish in the estimate mark. This helps you to make the right decision when casting your net.

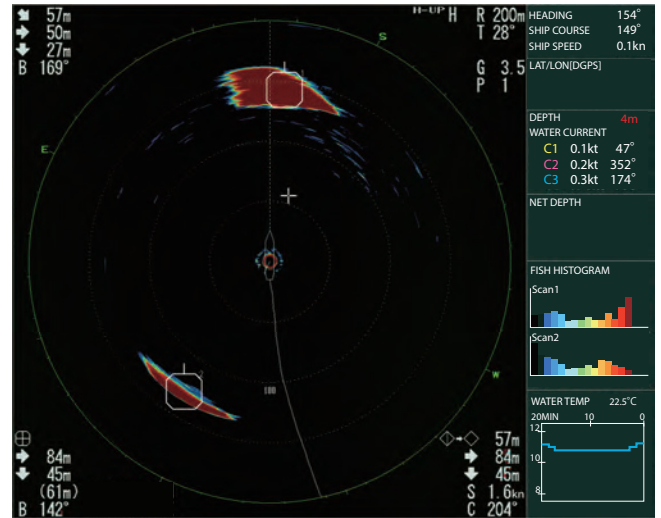

Up to two fish quantity marks can be typed on one screen, and the response of each is displayed as a histogram. This is useful for determining the amount of fish.

## ▶ Storage and playback of Sonar images

The FSV-85-MARK-2 allows you to take a screenshot and playback Sonar images.

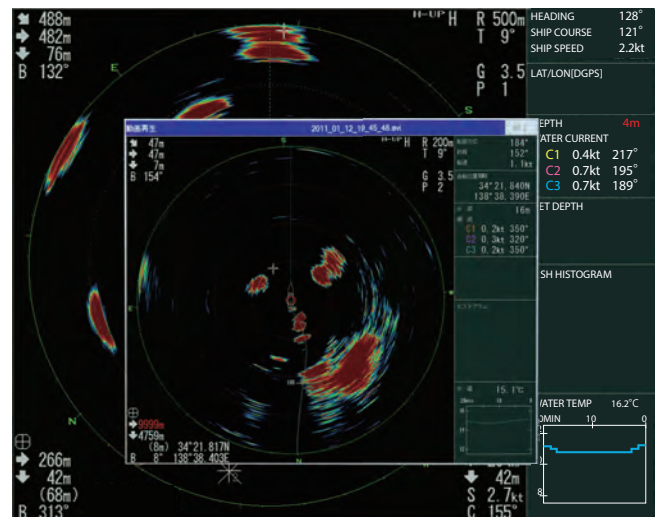

The recording will be played on a pop-up screen.



## ▶ User-Friendly, Programmable, Intelligent Controls

The User Program Control (up to 10 programs) provides for instant setup of the equipment according to fishing ground or target fish. Ten programs may be set up, and vertical and horizontal display settings may be programmed together or individually. In addition, 10 function keys provide one-touch display of desired menu or frequently used menu settings such as: Recording still images, recalling still images, erasing marks, activate or deactivate the stabilization etc.

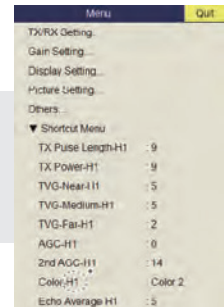
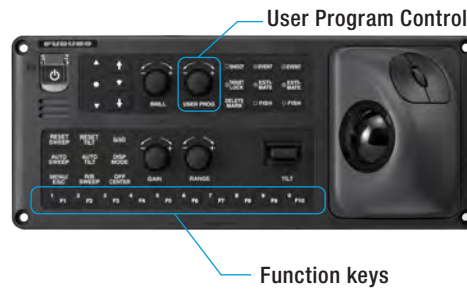

Customizable Menu

## ▶ Sub Control Unit and Remote Controller (wired) optionally available



Sub control unit



Remote Controller (wired)

+ *FSV-85-MARK-2 also allows the use of a USB wireless mouse*

## ▶ Short raise/lower time of the transducer & intuitive position indicator

The greatly reduced raise/lower time of the transducer allows for quick adjustment to prevent damage to the transducer.

Travel	Time (seconds)
800 mm	8
1100 mm	11

The position indicator (On the right) lets you know the position of the transducer at a glance.

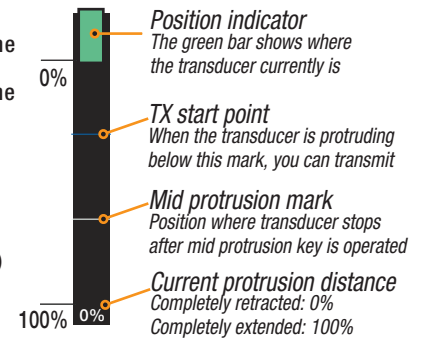

## Dual Display

A dual display configuration allows the user to display information on two monitors simultaneously. This is very useful for viewing information quickly on each of the two monitors and for comparing them.



 Perfect with our High Resolution MU displays

# Specifications

## 1. General

Scanning method: Full digital beam forming  
 Frequency: 80 kHz  
 Range: 60, 100, 150, 200, 300, 400, 500, 600, 700, 800, 900, 1000, 1100, 1200, 1400, 1600, 2000 m  
 Audio search: 30°, 60°, 90°, 180°, 330° (selectable)  
 Audio input: Audio terminal

## 2. Monitor Unit (Option)

Resolution: SXGA(1280x1024), UXGA(1600x1200), WUXGA(1920x1200)  
 Color: 32 colors (sonar picture), 6 colors (marks)  
 Orientation: Head-up, North-up\*, Course-up\* and True-motion\* (\*: sensor required)  
 Modes: Horizontal, S-scan, Horizontal combination, S-scan combination, Vertical 1 combination, Vertical 2 combination, Echo sounder combination, Vertical 1 + echo sounder  
 Features: Custom mode, Interference rejecter, Echo Average, Noise limiter, Signal level, Auto-tilt, Automatic target tracking (target lock), Fish alarm, Over-voltage warning, Unretracted transducer warning

## 3. Transceiver Unit

Transmitter: PDM half-bridge  
 Receiving method: Straight amplifier, full digital beam forming  
 H-mode beam-width: TX: 360°x 10.7°RX: 12.6°x 10.1 (-6 dB full width)  
 V-mode beam-width: TX: 12.7°x 118.2°RX: 12.6°x 12.1 (-6 dB full width)  
 S-mode beam-width: TX: 206.7°x 12.1°RX: 12.6°x 12.0 (-6 dB full width)  
 Tilt angle: -5° to 90°(downward)  
 Vertical search range: 0 to 90°(downward)

## 4. Hull Unit

Travel (mm)	Type (Less dome)	Raise/Lower time (sec)	Ship's speed allowance (at R/L operation)
800	FSV-8472-MK2	8	18 kn
1100	FSV-8482-MK2	11	15 kn

## 5. Interface

Number of ports  
 Serial 5 ports, NMEA0183 (Ver1.5/2.0/3.0/4.0/4.1)  
 LAN 2 ports, Ethernet, 10/100/1000Base-T  
 USB 4 ports (USB2.0: 1, USB3.0: 2)  
 External KP 2 ports (in: 1, out: 1), current loop or voltage signal  
 Gyrocompass 1 port, AD-10 format

## Data sentences

Input: CUR, DBS, DBT, DPT, GGA, GLL, GNS, HDG, HDM, HDT, MDA, RMA, MTW, MWV, RMC, VBW, VDR, VHW, VTG, VWR, VWT, ZDA  
 Output: TLL  
 Output proprietary sentence  
 PFEC: evt, fkv, fmg, fvc, pidat, sht, tlm, tqm, tfm

## 6. Power Supply

Processor Unit: 12-24 VDC: 4.0-2.0A, 48 W max  
 Transceiver Unit: AC100/110/115/220/230 V: 15A, 1Φ, 50/60Hz  
 Hull Unit: 200-220VAC: 4 A, 3Φ, 50/60Hz  
 Rectifier(Option): PR-241, 100-230 VAC single phase, 50/60Hz

## 7. Environmental Condition

Ambient Temperature:  
 Processor Unit -15°C~+55°C  
 Transducer -5°C~+35°C  
 Control Unit, Other -15°C~+55°C  
 Relative humidity: 93% max(+40°C)  
 Protection: Control Unit IP22 (Panel), IP20 (Chassis)  
 Processor Unit IP22  
 Transducer IPX8  
 Transceiver, Other IPX0  
 Vibration: IEC60945 Ed.4

# Equipment list

## Standard configuration

- Control Unit (Cable 10m) FSV-8501-MK2
- Processor Unit FSV-8503-MK2
- Transceiver Unit FSV-851C-MK2-80-E
- Hull Unit FSV-8472/8482-MK2
- Installation Materials
- Spare Parts

## Option

- Rectifier
- Control Unit (Cable 5m/10m) FSV-8501-MK2
- Remote Box/Cable (5P, 100m)
- Installation Kit (LAN Cable 20,30,40m)
- Retraction Tank
- Attachment Kit
- Sub Control Unit FSV-853
- Remote Controller FSV-854-MK2

# Interconnection Diagram

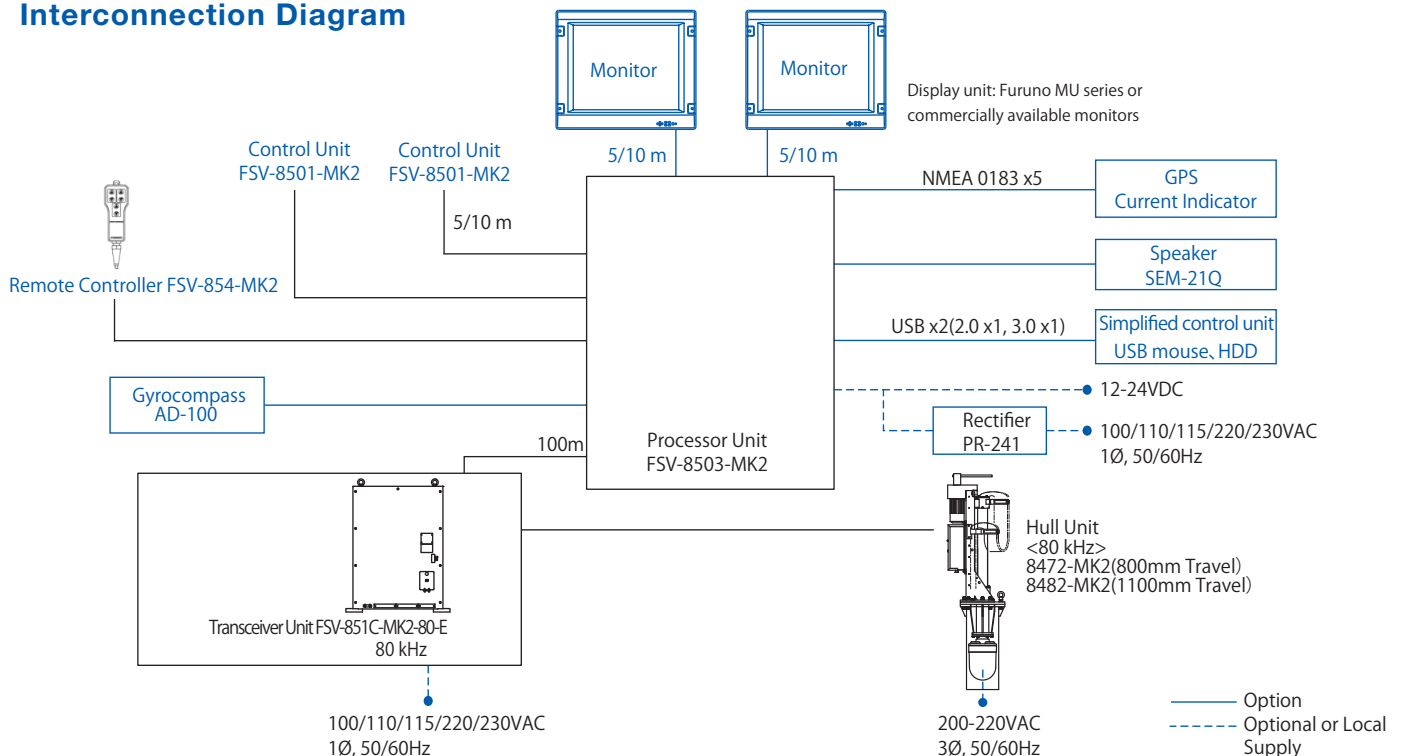

Full-Circle Color Scanning Sonar  
Model **FSV-85 MARK-2**

### Control Unit FSV-8501-MK2

3.8 kg 8.3 lb

※ When using the standard mounting bracket  
 ※ For recessed installations, the mounting hole dimensions are different.

### Processor Unit FSV-8503-MK2

15 kg 33 lb

### Hull Unit FSV-8472/8482-MK2

800 mm: 370 kg 816 lb  
 1100 mm: 390 kg 860 lb  
 (includes tank)

FSV-8400 Series: 80 kHz

■ mm  
 ■ inch

800 mm FSV-8472-MK2  
 1100 mm FSV-8482-MK2

### Transceiver Unit FSV-851C-MK2

95 kg 209 lb

### Remote Controller FSV-854-MK2

0.47 kg 1 lb

All brand and product names are registered trademarks, trademarks or service marks of their respective holders.  
 SPECIFICATIONS SUBJECT TO CHANGE WITHOUT NOTICE

- |  |  |   |  |  |
|--|--|---|--|--|
| <p><b>FURUNO ELECTRIC CO., LTD.</b><br/>                 Japan   www.furuno.com</p> <p><b>FURUNO U.S.A., INC.</b><br/>                 U.S.A.   www.furunousa.com</p> <p><b>FURUNO PANAMA S.A.</b><br/>                 Republic of Panama   www.furuno.com.pa</p> <p><b>FURUNO (UK) LIMITED</b><br/>                 U.K.   www.furuno.co.uk</p> <p><b>FURUNO NORGE A/S</b><br/>                 Norway   www.furuno.no</p> | <p><b>FURUNO DANMARK A/S</b><br/>                 Denmark   www.furuno.dk</p> <p><b>FURUNO SVERIGE AB</b><br/>                 Sweden   www.furuno.se</p> <p><b>FURUNO FINLAND OY</b><br/>                 Finland   www.furuno.fi</p> <p><b>FURUNO POLSKA Sp. Z o.o.</b><br/>                 Poland   www.furuno.pl</p> <p><b>FURUNO DEUTSCHLAND GmbH</b><br/>                 Germany   www.furuno.de</p> | <p><b>FURUNO FRANCE S.A.S.</b><br/>                 France   www.furuno.fr</p> <p><b>FURUNO ESPAÑA S.A.</b><br/>                 Spain   www.furuno.es</p> <p><b>FURUNO ITALIA S.R.L.</b><br/>                 Italy   www.furuno.it</p> <p><b>FURUNO HELLAS S.A.</b><br/>                 Greece   www.furuno.gr</p> <p><b>FURUNO (CYPRUS) LTD</b><br/>                 Cyprus   www.furuno.com.cy</p> | <p><b>FURUNO EURUS LLC</b><br/>                 Russian Federation   www.furuno.ru</p> <p><b>FURUNO SHANGHAI CO., LTD.</b><br/>                 China   www.furuno.com/cn</p> <p><b>FURUNO CHINA CO., LTD.</b><br/>                 Hong Kong   www.furuno.com/cn</p> <p><b>FURUNO KOREA CO., LTD</b><br/>                 Korea</p> <p><b>FURUNO SINGAPORE</b><br/>                 Singapore   www.furuno.sg</p> | <p><b>PT FURUNO ELECTRIC INDONESIA</b><br/>                 Indonesia   www.furuno.id</p> <p><b>FURUNO ELECTRIC (MALAYSIA) SND. BHD.</b><br/>                 Malaysia   www.furuno.my</p> |
|--|--|---|--|--|