

FURUNO

OPERATOR'S MANUAL

1st WATCH WIRELESS RADAR

Model

DRS4W

PRODUCT NAME: RADAR SENSOR

IMPORTANT NOTICES

General

- This manual has been authored with simplified grammar, to meet the needs of international users.
- The operator of this equipment must read and follow the descriptions in this manual. Wrong operation or maintenance can cancel the warranty or cause injury.
- Do not copy any part of this manual without written permission from FURUNO.
- If this manual is lost or worn, contact your dealer about replacement.
- The contents of this manual and equipment specifications can change without notice.
- The example screens (or illustrations) shown in this manual can be different from the screens you see on your display. The screens you see depend on your system configuration and equipment settings.
- Save this manual for future reference.
- Any modification of the equipment (including software) by persons not authorized by FURUNO will cancel the warranty.
- The following concern acts as our importer in Europe, as defined in DECISION No 768/2008/EC.
 - Name: FURUNO EUROPE B.V.
 - Address: Ridderhaven 19B, 2984 BT Ridderkerk, The Netherlands

Trademark Notices

- All brand and product names are trademarks, registered trademarks or service marks of their respective holders.
- Apple, iPad and iPhone are registered trademarks of Apple, Inc.
- App Store is a registered service mark of Apple, Inc.
- iOS is a registered trademark of Cisco Systems, Inc.

How to discard this product

Discard this product according to local regulations for the disposal of industrial waste. For disposal in the USA, see the homepage of the Electronics Industries Alliance (<http://www.eiae.org/>) for the correct method of disposal.

How to discard a used battery

Some FURUNO products have a battery(ies). To see if your product has a battery, see the chapter on Maintenance. Follow the instructions below if a battery is used. Tape the + and - terminals of battery before disposal to prevent fire, heat generation caused by short circuit.

In the European Union

The crossed-out trash can symbol indicates that all types of batteries must not be discarded in standard trash, or at a trash site. Take the used batteries to a battery collection site according to your national legislation and the Batteries Directive 2006/66/EU.

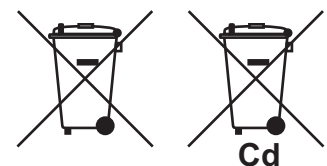

In the USA

The Mobius loop symbol (three chasing arrows) indicates that Ni-Cd and lead-acid rechargeable batteries must be recycled. Take the used batteries to a battery collection site according to local laws.

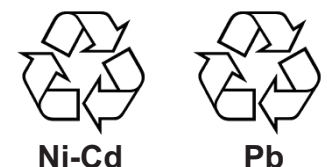



In the other countries

There are no international standards for the battery recycle symbol. The number of symbols can increase when the other countries make their own recycle symbols in the future.









SAFETY INFORMATION

Read these safety instructions before installing or operating the equipment.









 WARNING	Indicates a potentially hazardous situation which, if not avoided, can result in serious injury or death.
 CAUTION	Indicates a potentially hazardous situation which, if not avoided, can result in minor or moderate injury.

 Warning, Caution	 Prohibitive Action	 Mandatory Action
--	--	--





Safety Information for the Operator

 WARNING							
	ELECTRICAL SHOCK HAZARD Do not open the equipment. There are no user servicable parts inside.						
	Wear a safety belt and hard hat when working on the antenna unit. Serious injury or death can result if someone falls from the radar mast.						
	The radar antenna emits electromagnetic radio frequency (RF) energy which can be harmful, particularly to your eyes. Never look directly into the antenna aperture from a close distance while the radar is in operation or expose yourself to the transmitting antenna at a close distance. Distances at which RF radiation levels of 100, 50 and 10 W/m ² exist are given in the table below.						
<table border="1"> <tr> <td>100 W/m²</td> <td>50 W/m²</td> <td>10 W/m²</td> </tr> <tr> <td>N/A</td> <td>N/A</td> <td>0.0 m</td> </tr> </table>		100 W/m ²	50 W/m ²	10 W/m ²	N/A	N/A	0.0 m
100 W/m ²	50 W/m ²	10 W/m ²					
N/A	N/A	0.0 m					
	Do not disassemble or modify the equipment. Fire, electrical shock or serious injury can result.						
	Use the proper fuse. Use of a wrong fuse can damage the equipment or cause fire.						
	Do not depend one navigation device for the navigation of the vessel. For the safety of vessel and crew, the navigator must check all aids available to confirm position.						

Safety Information for the Installer





 WARNING					
	Do not open the equipment. The installation does not require you to open the radar sensor.				
	Wear a safety belt and hard hat when working on the antenna unit. Serious injury or death can result if someone falls from the radar mast.				
	Be sure the power source is compatible with the voltage rating of the equipment. Connection of an incorrect power source can cause fire or damage the equipment.				
	Turn off the power at the power source before beginning the installation. Fire, electrical shock or serious injury can result if the power is left on or is applied while the equipment is being installed.				
 NOTICE					
	Observe the following compass safe distance to prevent interference to a magnetic compass.				
<table border="1"> <tr> <td>Standard compass</td> <td>Steering compass</td> </tr> <tr> <td>1.45 m</td> <td>0.90 m</td> </tr> </table>		Standard compass	Steering compass	1.45 m	0.90 m
Standard compass	Steering compass				
1.45 m	0.90 m				
	It is recommended that you connect the sensor to a disconnecting device (circuit breaker, etc.) to control the power.				

Safety Information for the Operator

 NOTICE	
	<p>Do not expose the radar sensor to strong water jets. Excessively strong water jets can damage the sensor.</p>
	<p>The radar picture may not be updated when the WLAN signal is weak. If the WLAN signal is weak, discontinue use of the sensor, to prevent trouble associated with un-updated picture.</p>
	<p>Keep the sensor and iOS terminal away from products which use the 2.4 GHz wireless LAN radio band (Bluetooth devices, microwave range, etc.), to prevent malfunction. Discontinue use of the sensor if it receives microwave interference.</p>
	<p>The sensor cannot function properly if there is trouble (equipment trouble, low battery voltage, etc.) with the iOS terminal. For this reason, it is recommended to keep more than one iOS terminal on board in case of trouble.</p>

WARNING LABEL

A warning label is attached to the sensor. Do not remove the label. If the label is missing or damaged, contact a FURUNO agent or dealer about replacement.

 WARNING 	 警告 
To avoid electrical shock, do not remove cover. No user-serviceable parts inside.	感電の恐れあり。 サービスマン以外の方はカバーを開けないで下さい。内部には高電圧部分が多い数多くあり、万一さわると危険です。

Name: Warning Label (2)

Type: 03-129-1001-3

Code No: 100-236-743

TABLE OF CONTENTS

FOREWORD	v
1. OPERATION	1
1.1 System Overview	1
1.2 How to Start, Stop the System	1
1.3 Transmit, Standby	2
1.4 Display Layout.....	2
1.5 Touch Screen Operations	3
1.6 Picture Menu	3
1.7 How to Adjust the Brilliance	4
1.8 How to Select a Display Range.....	4
1.9 How to Set a Guard Alarm Zone	4
1.10 How to Reduce Rain Clutter.....	5
1.11 How to Measure the Bearing and Range to a Target.....	5
1.12 How to Off Center the Display.....	5
1.13 Echo Stretch.....	6
1.14 Palette	6
1.15 Echo Color	6
1.16 Picture Format.....	6
1.17 How to Lock the Display (iPhone only)	6
1.18 How to Take a Screenshot of the Display	7
1.19 Settings Menu	7
2. MAINTENANCE, TROUBLESHOOTING	8
2.1 Maintenance.....	8
2.2 Replacement of Fuse	8
2.3 Troubleshooting	9
2.4 Error Messages.....	9
2.5 Replacement of Magnetron.....	9
2.6 Self Test.....	10
3. INSTALLATION	11
3.1 Equipment List	11
3.2 Installation Considerations	11
3.3 How to Install the Radar Sensor	12
3.4 How to Set up the Radar Sensor	15
3.4.1 How to start the system	15
3.4.2 Heading, timing adjustment	15
3.4.3 Range unit	17
3.4.4 Tuning initialization	17
3.4.5 Sector blank.....	17
MENU TREE	AP-1
RADIO REGULATORY INFORMATION	AP-2
SPECIFICATIONS	SP-1

FOREWORD

A Word to the Owner of the DRS4W

Congratulations on your choice of the FURUNO RADAR SENSOR DRS4W.

Since 1948, FURUNO Electric Company has enjoyed an enviable reputation for innovative and dependable marine electronics equipment. This dedication to excellence is furthered by our extensive global network of agents and dealers.

This equipment is designed and constructed to meet the rigorous demands of the marine environment. However, no equipment can perform its intended function unless installed, operated and maintained properly. Please carefully read and follow the recommended procedures for installation, operation, and maintenance.

We would appreciate hearing from you, the end-user, about whether we are achieving our purposes.

Thank you for considering and purchasing FURUNO.

Features

- Complies with wireless LAN standard IEEE802.11b.
- Radar sensor forwards radar echoes to an iPad or iPhone via the 2.4 GHz radio band.
- Compatible with the following iOS terminals (iOS 6.1.3, 7.0.4 or higher):
 - iPhone 5, 5c, 5s, 6 Plus
 - iPad 2, 3, 4, Air, Air2, mini, mini2, mini3
- Stylish radome-type radar sensor.
- Echoes shown in green or yellow, or multicolor in red, yellow or green, corresponding to strong, medium and weak echoes.
- 14 ranges from 0.125 to 24 NM.
- Brilliance adjustable to suit lighting conditions.

- Two iOS terminals can be connected to the radar sensor at the same time.
- Guard zone alarm watches for targets entering or exiting an alarm zone.
- Echo stretch lengthens echoes in range and/or bearing direction.
- Automatic adjustment of sea clutter (echoes from waves), gain, noise and interference.
- Off center feature lets you look focus on a specific area ahead of or around your vessel without losing track of position.
- Self test checks the radar sensor for correct operation.

System Configuration

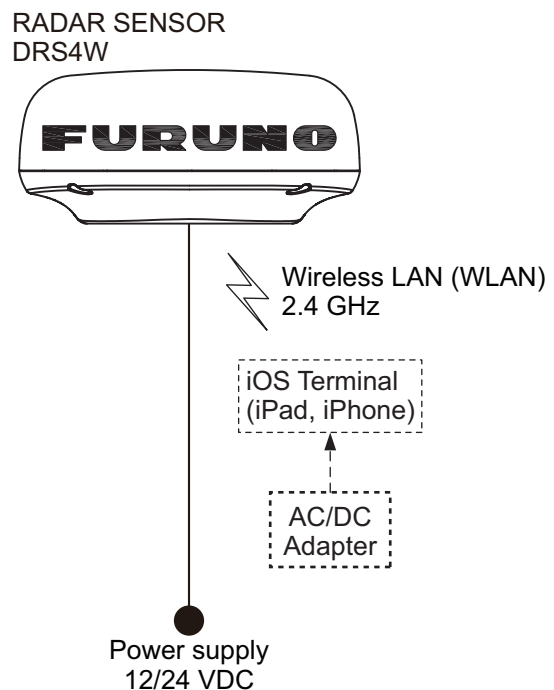

Program No.

- 0359329-01.**

** denotes minor modifications.

1. OPERATION

1.1 System Overview

The radar sensor transmits pulses of microwave energy that bounce off any object in their path. The object returns a tiny part of the wave's energy to the radar sensor. Radar determines the distance to a target by calculating the time difference between the transmission of a radar signal and the reception of the reflected echo. The bearing to a target found by the radar is determined by the direction in which the antenna is pointing when it emits an electronic pulse and then receives a returning echo.

The radar sensor forwards the returning echoes to the iOS terminal (iPhone, iPad), using its wireless LAN module. The radar application in the iOS terminal displays the radar echoes on the terminal's display and provides controls for adjustment of the radar picture.

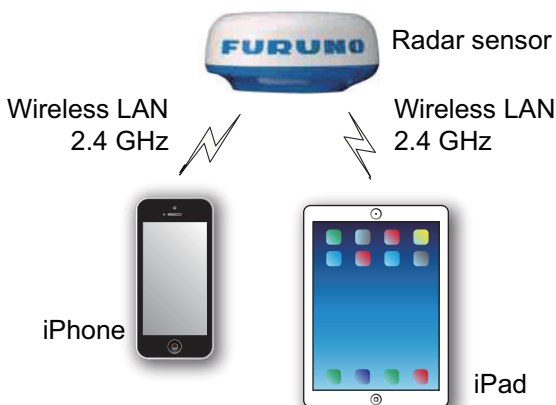

1.2 How to Start, Stop the System

Power the radar sensor to activate the system. Open your iPad or iPhone terminal and click the [Marine Radar] application icon (see right figure).

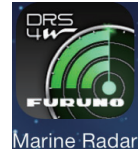

The splash screen appears for a few moments, then the application tries to connect to the radar sensor, which normally takes no more than three seconds. If the connection is successful, the [Preheating] display appears.

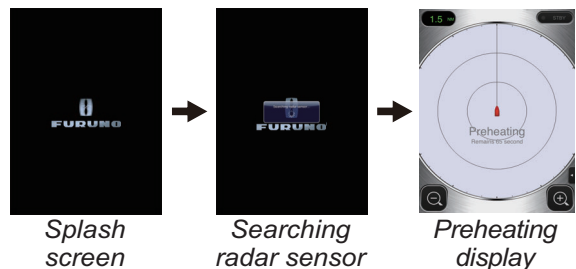

If the connection failed, the window shown right appears. Tap the [Search again] button to try to connect

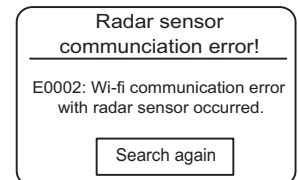

to the radar sensor. If you cannot connect to the radar sensor, check for interfering objects near the sensor and make sure the wireless LAN function is enabled on your terminal.

The preheating stage, which warms the magnetron (the device responsible for transmitting radar pulses), takes approx. 90 seconds. The time remaining until the completion of the preheating is counted down at the center of the screen. After the completion of the preheating, the STBY display appears.

To deactivate the system, disconnect the radar sensor from the power source.

Note: To connect an iOS terminal to another DRS4W, reset the application first.

1.3 Transmit, Standby

Tap the [STBY-TX] icon at the top right corner on the screen to put the radar in standby, transmit state alternately.

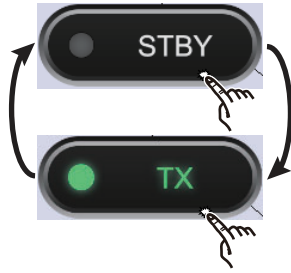

When you don't need the radar, set it to standby to extend the life of the magnetron.

Note: The radar application is set to standby one minute after you switch to another application.

1.4 Display Layout



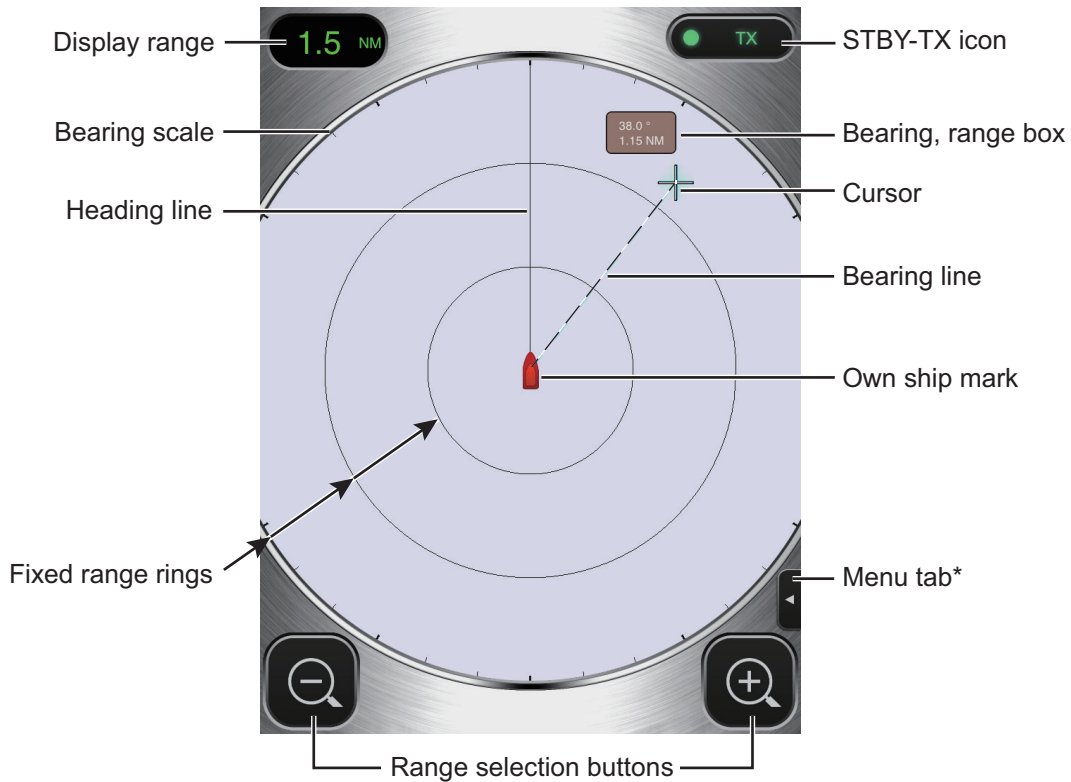



The figure below shows all the indications, markers and icons that appear on the iPad radar display. The layout on the iPhone is similar.

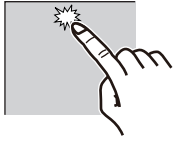

* Not provided on iPhone.

1.5 Touch Screen Operations

The table below shows all the basic touch screen operations.

Operation		Action	Operation		Action
Tap		<ul style="list-style-type: none"> • Open, close menus. • Operate various buttons. 	Drag		<ul style="list-style-type: none"> • Move the cursor. • Move slider bar in menus. • Off center the display.
Double tap		<ul style="list-style-type: none"> • Cancel off center display. 	Pinch in, Pinch out	 	<ul style="list-style-type: none"> • Select display range.
Long push (approx. 2 sec.)		<ul style="list-style-type: none"> • Display the cursor. 			

1.6 Picture Menu

This sensor has three menus: Picture, Color, and Settings. The Picture menu contains the most frequently used radar functions.

1. **iPad:** Tap the Menu tab at the right side of the screen to show the menu.

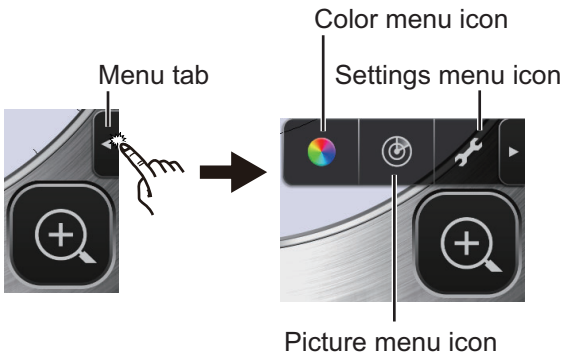

iPhone: Tap anywhere to show the menu.

2. Tap the (⊕) icon to activate the [Picture] menu.

3. Use the page selection buttons (</>) to browse the items of the menu. For example, select [Sector Blank].

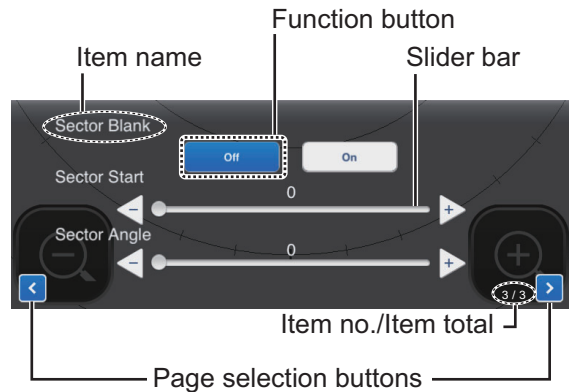

4. The [Picture] menu has several types of controls for adjustment.
 - Slider bar with < and > buttons:** Drag the slider bar to adjust the item selected. Use the < or > button to fine tune the setting.
 - Function buttons:** Tap the appropriate button to select the function labeled on the button.
5. To close the menu, tap anywhere outside the menu area.

1.7 How to Adjust the Brilliance

The brilliance can be adjusted to suit lighting conditions. Open the menu then tap the  icon. Drag the slider bar to adjust the brilliance.

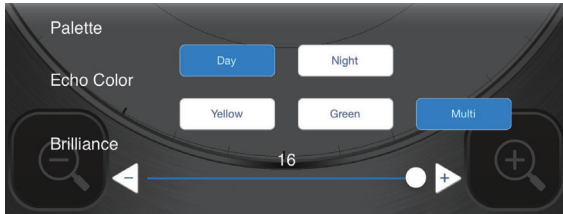

1.8 How to Select a Display Range

The range selects how far you want the radar to “see”. The range selected automatically determines the range ring interval, the number of range rings and pulse repetition rate. The current range is shown at the top left corner on the screen.

R	0.125	0.25	0.5	0.75	1
FRR	0.0625	0.125	0.125	0.25	0.25
NR	2	2	4	3	4
R	1.5	2	3	4	6
FRR	0.5	0.5	1	1	2
NR	3	4	3	4	3
R	8	12	16	24	
FRR	2	3	4	6	
NR	4	4	4	4	

R: Display range, FRR: Fixed range ring interval, NR: Number of fixed range rings

To select a display range, tap the range selection buttons at the bottom right and left corners. Alternatively, you can pinch in or pinch out within the display area.



Increase the range
(zoom out)

Decrease the range
(zoom in)

1.9 How to Set a Guard Alarm Zone

Follow below steps to set a guard alarm zone.

1. Tap the picture menu icon.

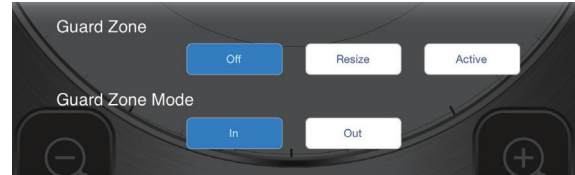

2. Tap [Resize] menu.
3. Four circles appear at the four corners of the guard zone.
4. Drag the circles to set the guard zone.
5. Tap [Active] menu.
6. The dotted lines turn to solid lines and guard zone appears.

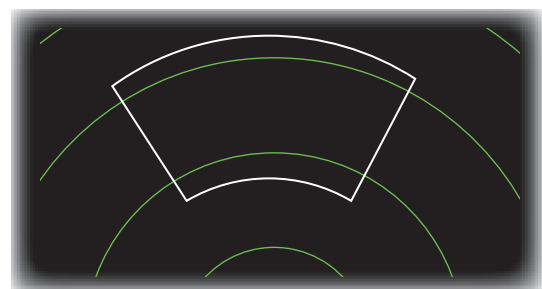
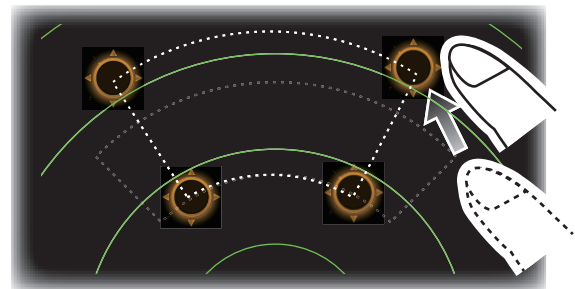
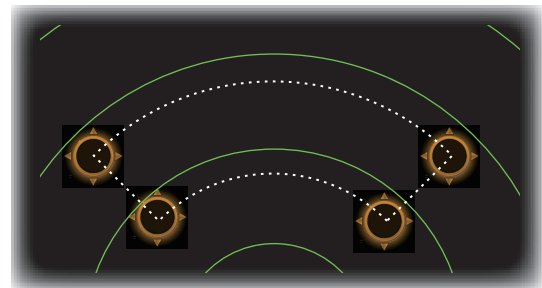

1. OPERATION

Guard Zone Mode

[In]: When the targets enter a target alarm zone, the alarm occurs.

[Out]: When the targets exit a target alarm zone, the alarm occurs.

1.10 How to Reduce Rain Clutter

The antenna picks up rain clutter (rain, snow, or hail) in the same manner as normal targets, as in the right figure. When rain clutter masks targets, use the [Rain] control to reduce the clutter. The higher the setting the greater the reduction of rain clutter



To adjust the rain clutter, open the menu then tap the (⊕) icon. Select the [Rain] screen. Tap the [Manual] or [Auto] button. For manual adjustment, drag the slider bar to reduce the rain clutter.

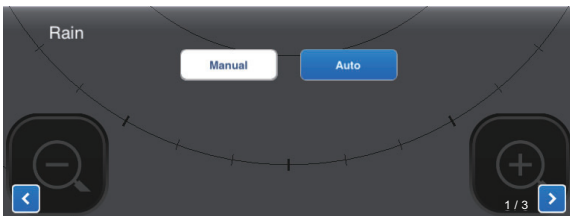

Automatic adjustment

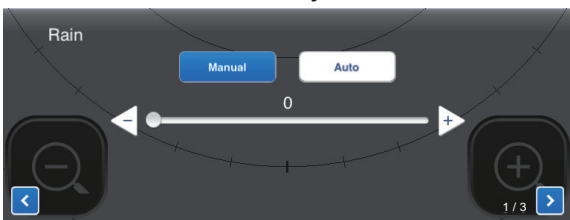

Manual adjustment

1.11 How to Measure the Bearing and Range to a Target

The bearing and range from own ship to a target can be measured with the cursor. Long push the screen to show the cursor, which is a cross (+). Drag the cursor to put it on the

center of the target. See the bearing and range to the target in the [Bearing/Range] box, which is to the side of the cursor. After several seconds, the cursor is erased from the screen.

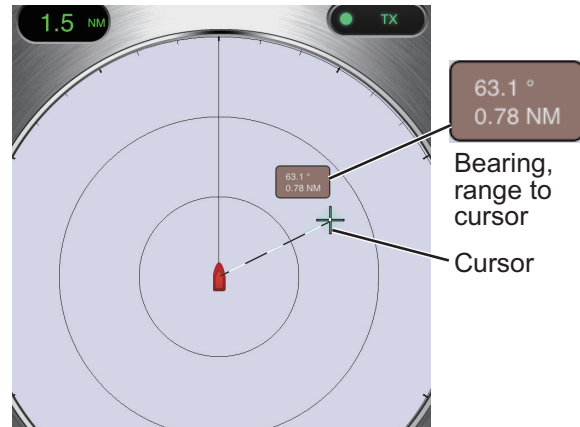

Note: A slight difference exists between finger position and cursor position in order to see the cursor while dragging it.

1.12 How to Off Center the Display

Own ship position, or sweep origin, can be displaced manually or automatically to expand the view without switching to a longer range. The maximum amount of shift is 75% of the range in use.

To off center the display, drag the own ship mark to the position you want to make the screen center. To return to the normal display, double tap the display area.

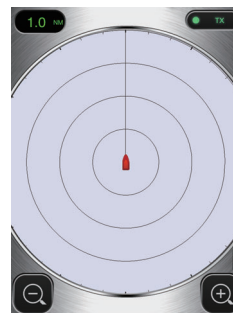

Normal display

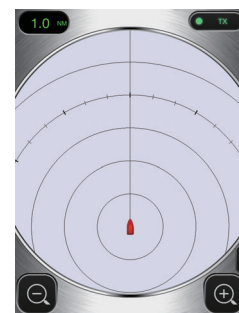

Off centered display

1.13 Echo Stretch

On long ranges, target echoes tend to shrink, making them difficult to see. To enhance target video on long ranges, use the echo stretch feature to lengthen echoes in the bearing and/or range direction.

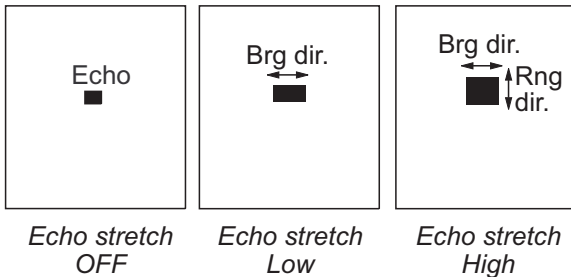

Open the menu then tap the (⊙) icon. Select the [Echo Stretch] screen. Select [Low] to lengthen echoes in the bearing direction; [High] to lengthen echoes in both the bearing and range directions.

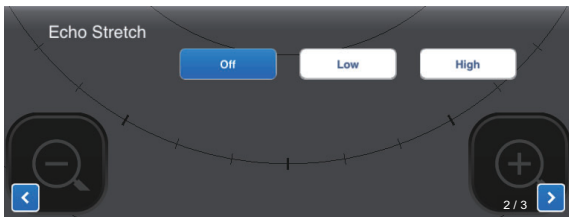

1.14 Palette

The palette feature changes the color of the background, characters, range rings and heading line to suit the time of day, daytime or nighttime.

Open the menu then tap the (🌈) icon. Select [Day] or [Night] as appropriate.



Item	Color	
	Day	Night
Background	White	Black
Characters	Gray	Red
Rings	Gray	Red
Heading line	Gray	Red

1.15 Echo Color

Echoes can be shown in yellow, green, or multicolor. Multicolor paints each radar echo in a color according to its strength, in red, yellow or green, corresponding to strong, medium and weak echoes. Open the menu then tap the (🌈) icon. Select the color desired at [Echo Color].



1.16 Picture Format

You can show the radar picture in landscape or portrait format. Rotate your terminal to change the format.*

* Only Portrait display is available on iPhone.

1.17 How to Lock the Display (iPhone only)

Tap the screen of iPhone. Tap the key icon of menu tab to lock the display. Tap the key icon of menu tab again to unlock.

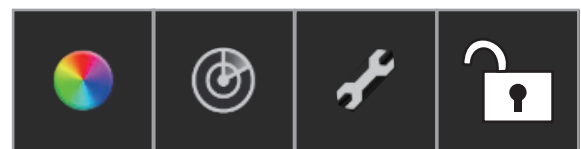

Note: The display lock is activated only when the radar application is shown on the top of iPhone or iPad. The display lock is deactivated when an alarm occurs.

1.18 How to Take a Screenshot of the Display

You can take a screenshot of the radar display, and save it to the Photos folder in your terminal. Push the Home and Power buttons together. You should hear the camera shutter sound.

1.19 Settings Menu

The [Settings] menu contains items that once preset do not require frequent adjustment. Open the menu then tap the (⚙️) icon to open the [Settings] menu.

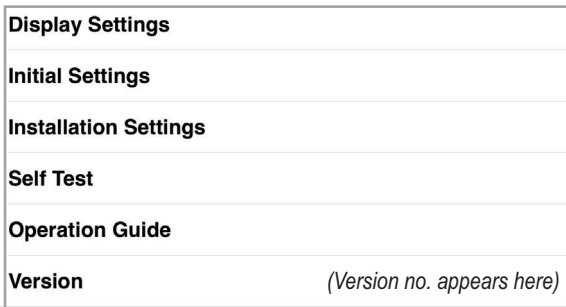

Display Settings menu

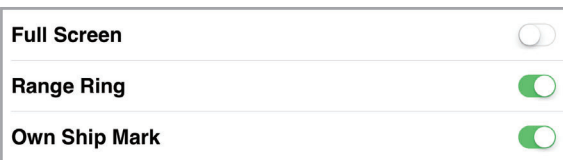

[Full Screen]: Turn the full screen display on or off.

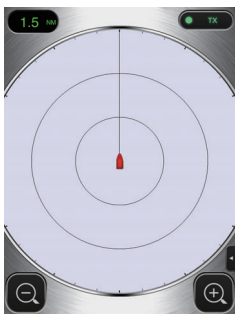

Full screen OFF

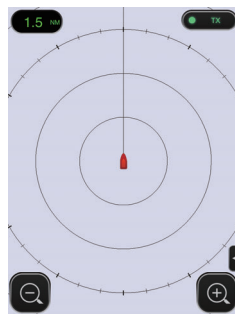

Full screen ON

[Range Ring]: The range rings are the concentric circles about own ship position, and they function to provide an estimate of the range to a target. You can turn the rings on or off here.

[Own Ship Mark]: The own ship mark is shown at the display center and indicates your current position. You can turn the mark on or off here.

Initial Settings menu

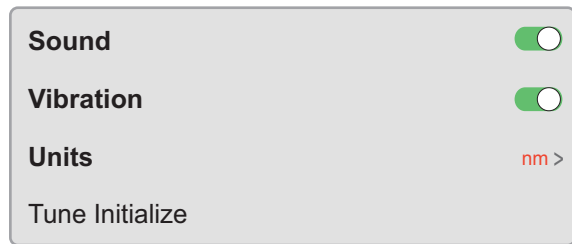

[Sound]: Turn on/off the alarm sound.*

* When iPhone or iPad is set on mute, there is no alarm sound.

[Vibration]: Turn on/off the alarm vibration.*

* For iPhone only.

[Units]: Select the unit of range measurement, nm or km.

[Tune Initialize]: Automatically tune the radar receiver. See the chapter on installation.

Installation Settings menu

The items in this menu are mainly intended for the serviceman. See the chapter on installation.

Self Test

Tests the radar sensor and radar application for proper operation. See the chapter on Maintenance.

Operation Guide

Operator's guide to the basic functions of this radar.

Version

Shows the software version no.

2. MAINTENANCE, TROUBLESHOOTING

 **WARNING**



DO NOT OPEN THE SENSOR.
Electrical shock hazard

There are no user-serviceable parts inside. Only qualified personnel are allowed to work inside the equipment.

2.1 Maintenance

Regular maintenance is important for good performance. Check the points mentioned below every 3 to 6 months to keep the radar sensor in good working order. Observe the safety instructions at the front of this manual when working on the mast.

Check point	Action
Check fixing bolts for corrosion and if tightly fastened.	Tighten loosened bolts. Replace corroded bolts. Coat new bolts with marine sealant.
Check radome for cracks, foreign material.	If a crack is found, repair it temporarily with a small amount of sealing compound or adhesive. Bring the unit to your dealer for permanent repairs. Foreign material on the radome can cause a considerable drop in sensitivity. Remove foreign material with a freshwater-moistened cloth. Do not use commercial cleaners to clean the sensor; they can remove paint and markings or deform the plastic.

NOTICE

Do not apply paint, anti-corrosive sealant or contact spray to coating or plastic parts. Those items contain organic solvents that can damage coating and plastic parts.

2.2 Replacement of Fuse

The 5A fuse (Type: FGBO 250V 5A PBF, Code No.: 000-155-840-10) in the fuse holder on the power cable protects the radar sensor from overcurrent and equipment fault. If you cannot turn on the power, check the fuse to see if it has blown. If the fuse has blown, find the reason before you replace the fuse. If the fuse blows again after the replacement, contact your dealer for advice.

 **WARNING**

Use the proper fuse.

Use of the wrong fuse can damage the equipment or cause fire.

2.3 Troubleshooting

The table below provides simple troubleshooting procedures that the user can follow to restore normal operation. If you cannot restore normal operation, contact your dealer for advice.

Trouble	Remedy
The power cannot be turned on.	<ul style="list-style-type: none"> • Check if the power cable is connected to the power source and the power source is on. • Check the power cable for damage. • Check if the fuse has blown.
The power is on but nothing appears on the display.	Try adjusting the brightness with [Brightness] in the [Settings] menu in your terminal, or [Brilliance] in the radar application.
The display freezes.	<ul style="list-style-type: none"> • Restart the application. • Reset your terminal.
You cannot connect to the wireless LAN but you can see the host on the terminal.	<ul style="list-style-type: none"> • Switch between standby and transmit. • Restart the application. • Check the WLAN settings in your terminal. • Restart your terminal.

2.4 Error Messages

Error messages are shown to alert you to radar sensor problems. The table below shows the error messages and accompanying message numbers and check points. These alerts appear in the background; no notification is given.

Message	Message no. and check point
"No radar sensor found!"	E0001: Please check Wi-Fi connection setup and if power is applied to radar sensor.
"Radar sensor communication error!"	E0002: Wi-fi communication error with radar sensor occurred.
"Radar sensor signal error!"	E0003: Heading pulse from radar sensor is not detected. Please check radar sensor condition.
	E0004: Video signal from radar sensor is not detected. Please check radar sensor condition.
"Guard zone area is out of the current range scale!"	E0005: Please adjust the range scale or move the guard zone closer to your location.
"Target Alarm!"	Target(s) entered the guard zone.
	Target(s) exited the guard zone.

2.5 Replacement of Magnetron

The life expectancy of the magnetron is approx. 5,000 hours (including standby). The effectiveness of the magnetron decreases over time, causing lower-than-normal signal strength and loss of echoes. If you feel the signal strength is low, contact your dealer about replacement of the magnetron.

Name	Type	Code no.
Magnetron	E3571	000-126-646

2.6 Self Test

The self test is for use by the service technician to check the equipment. However, the user can do the test to support the service technician.

1. Open the menu then tap the (🔧) icon.
2. Tap [Self Test] to do the self test.

Self Test	
App version	03593929-xx.xx
Boot version	03593930-xx.xx
FPGA version	0359313-xxxxxxx-xx
WLAN FW version	2.4.3-2.4.3-2.4.1
IP Address	172.31.x.xx
Subnet Mask	255.255.0.0
Gateway	172.31.x.xx
Mac Address	xx-xx-xx-xx-xx-xx
ROM	OK
RAM	OK
WLAN Status	OK
WLAN Channel	x
WLAN Power	15dBm
TX-HV	334.1V
5V	5.1V
12V	12.4V
Antenna Status	OK

↓ Scroll

Heading Pulse	OK
Tx Trigger	OK
Video Status	OK
Antenna Rotation	0.0rpm
Tuning Voltage	0.0V
Tune Indicator	0.0
Tx Time	60.1H
On Time	119.3H
Magnetron Monitor	1.7V

WLAN=Wireless LAN

Actual value appears in place of “x”.

The result for [ROM], [RAM], [WLAN Status] and [Antenna Status] is [OK] or [NG] (No Good). If [NG] appears for an item, try the test again, or restart the radar sensor. If [NG] appears again, contact your dealer for advice.

3. INSTALLATION

3.1 Equipment List

Name	Type	Code No.	Qty	Remarks
Standard supply				
Radar Sensor	RSB-126-103	-	1	
Installation Materials	CP03-35800	000-024-974	Select one	Power cable assy., 10 m
	CP03-35810	000-024-975		Power cable assy., 15 m
	CP03-35820	000-024-976		Power cable assy., 20 m
	CP03-35830	000-024-977		Power cable assy., 30 m
	CP03-35701	001-265-920	1	- Hex bolt*(M10×25), 4 pcs. - Flat washer (M10 SUS304), 4 pcs. - Spring washer (M10 SUS304), 4 pcs. *For use if thickness of platform is 6–10 mm.
Documents	OME-36360	-	1	Operator's Manual
	MDC-36360	-	1	C-ROHS list
	E32-01314	-	1	Template
	E32-01401	-	1	SSID, password information
	E32-01405	-	1	Notes on usage
Spare Parts	SP03-17801	001-265-910	1	5A fuse, 2 pcs.
Optional supply				
Radome Mount	OP03-209	001-078-350	1	Mast mounting bracket for sailboat

3.2 Installation Considerations

General considerations:

- Do not apply paint, anti-corrosive sealant or contact spray to coating or plastic parts. Those items contain solvents that can damage coating and plastic parts.
- The radar sensor has no power switch. Therefore, it is recommended that you connect the sensor to a disconnecting device (circuit breaker, etc.) to control the power.

Sensor placement:

- The radar sensor uses the 2.4 GHz wireless LAN radio band to forward radar echoes to the iOS terminal. Separate the sensor well away from products which also use this band (microwave range, Bluetooth devices, etc.) to prevent mutual interference.
- Install the radar sensor on the hardtop, radar arch or on a mast on an appropriate platform. (For sailboats, a “radome mount” is optionally available for fixing the sensor to a mast.) Place the sensor where there is a good all-round view with, as far as possible, no part of the ship's superstructure or rigging intercepting the scanning beam. Any obstruction will cause shadow and blind sectors. Be sure there are no metallic objects near the antenna. See the next page for typical placement on a sailboat and powerboat.
- Observe the wireless LAN communication range noted in the illustration on the next page.
- In order to reduce the chance of picking up electrical interference, avoid where possible routing the power cable near other electrical equipment onboard. Also, avoid running the cable in parallel with other power cables.
- Select a location that does not allow water to accumulate at the base of the sensor.
- A magnetic compass will be affected if the radar sensor is too close to the compass. Observe the compass safe distances mentioned on page ii to prevent interference to a magnetic compass.

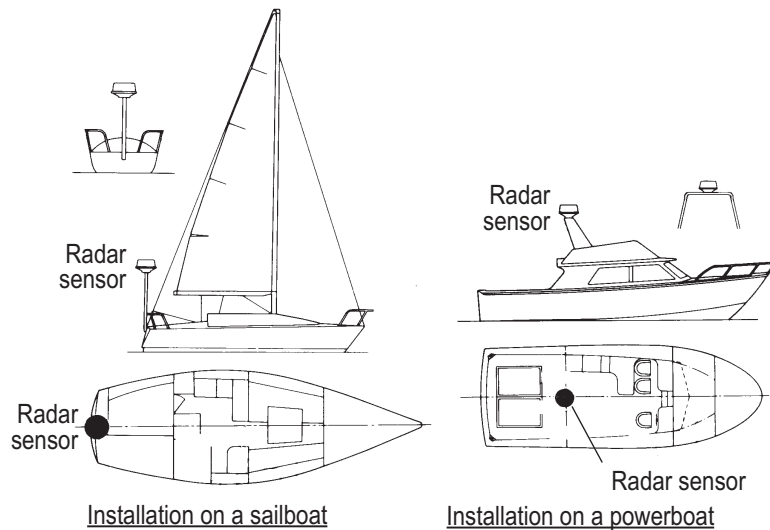

Typical installation on a sailboat, power boat

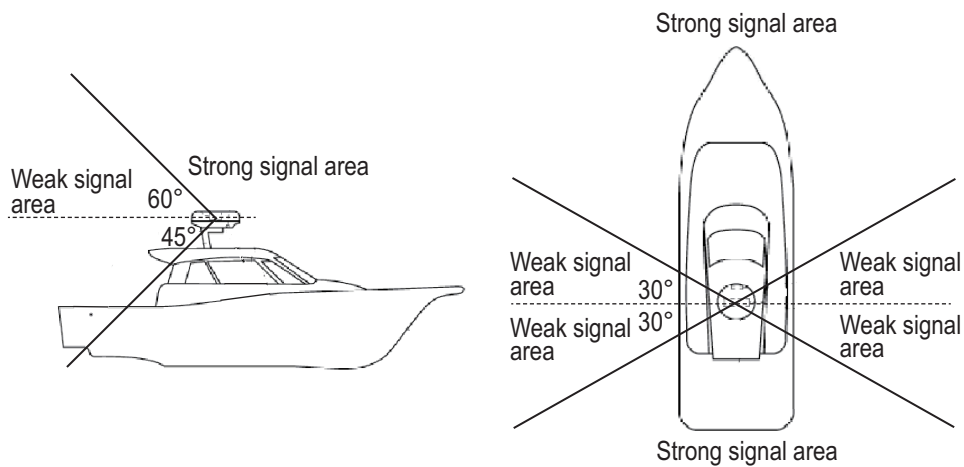

Location and wireless LAN communication range

3.3 How to Install the Radar Sensor

Determine the suitability of the mounting location **BEFORE** permanently mounting the sensor. Incoming and outgoing signals may overlap one another depending on the shape of the vessel, preventing communication between the terminal and the sensor. Set the sensor on the selected location and connect the sensor to the power source. Turn on the sensor. Open the terminal, turn on the radar application and try to connect the terminal to the sensor (see section 3.4.1 for how to start the system). If the connection is successful, change the range to check if the sensor receives your command. Check that the picture is updated with each sweep. Some trial and error may be necessary to find a suitable location.

Installation on a platform

1. Remove the mounting hardware at the bottom of the radar sensor - four each of hex bolts (M10×20), spring washers and flat washers. Save the spring washers and flat washers to use them to fasten the radar sensor to the platform, at step 4. If the thickness of the platform is 5 mm or less, also save the bolts.

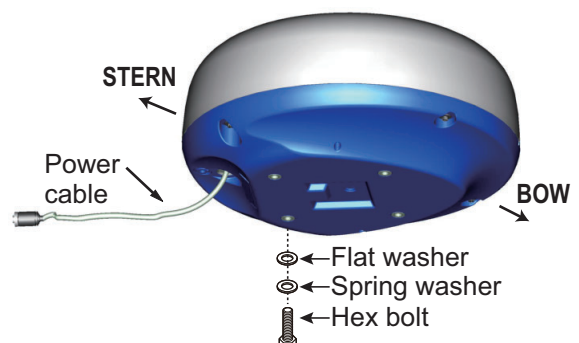

3. INSTALLATION

- Construct a platform (steel or aluminum) referring to the outline drawing and the mounting template. Fasten the platform to the mounting location. The holes in the platform must be parallel with the fore and aft line.
- Put the radar sensor on the platform with the bow mark (Δ) on sensor aligned with the bow.
- Use hex bolts*, flat washers and spring washers (removed at step 1) to fasten the radar sensor to the platform. The torque for the bolts must be 19.6 to 24.5 N·m.
*See the figure below to determine bolt length to use.

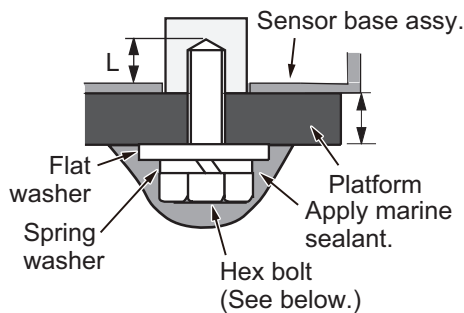

Platform thickness and bolt to use

Platform thickness	Bolt to use
5 mm or less	M10×20 (Supplied, prefastened to radome.)
6 - 10 mm	M10×25 (Supplied.)
Over 10 mm	Use bolt where the length of "L" above is 15 mm. Supply locally.

Note: The outer diameter of the small flat washer is the same size as the bolt hole. If the radome is put upside down with only the small flat washer and hex bolt in place, the hex bolt and flat washer may protrude into the radome and damage the RT unit and W-LAN antenna. For this reason, DO NOT put the radome upside down when carrying the radome.

If it is necessary to transport the radome, be sure the large flat washers are in place before transporting, to prevent damage to the RT unit and W-LAN antenna.

Default position of bolt and washer

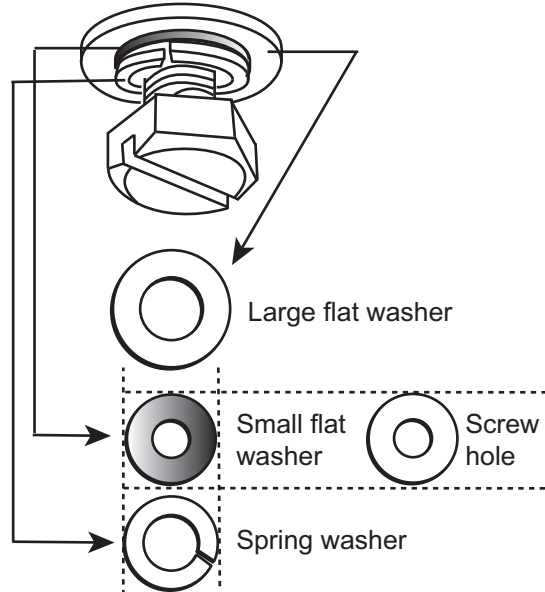

- Connect the supplied power cable to the sensor. Observe the guidelines for laying the power cable shown on this page.
- Connect the power cable to the power source.

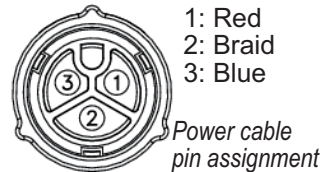

Guidelines for laying the power cable

- The connectors must not strike any part of the vessel by wind, etc.
- The load applied to the connectors must not be more than its own weight.
- If the cable is passed through a mast on a sailboat, be sure the cable does not touch ropes (sheet, halyard, etc.).
- Do not fasten the cable to the hull.

- The cable must be fixed so no tension is applied to the connectors. To prevent tension, create a loop in the cable close to the sensor and tie the loop with cable ties, as in the figure below.

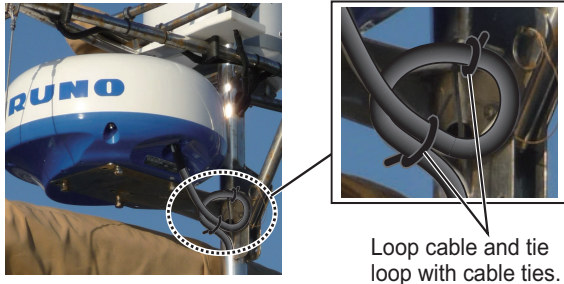

- Wrap the junction of the connectors with self vulcanizing tape for waterproofing.
- Fasten the cable to the mast, etc. at the neck of each connector with a cable tie.

Installation with the radome mount

The optional radome mount lets you fasten the radar sensor to a mast on a sailboat.

Name, Type: Radome Mount, OP03-209
Code No.: 001-078-350

Name	Type	Code No.	Qty
Mounting plate	03-018-9001-0	100-206-740-10	1
Support plate (1)	03-018-9005-0	100-206-780-10	1
Support plate (2)	03-018-9006-0	100-206-790-10	1
Bracket (1)	03-028-9101-1	100-206-811-10	1
Bracket (2)	03-028-9101-2	1	
Fixing plate	03-028-9103-1	100-206-831-10	2
Hex bolt w/washer	M8×20 SUS304	000-162-955-10	8
Hex bolt w/washer	M4×12 SUS304	000-162-956-10	4

How to assemble the bracket

1. Fasten the fixing plates to brackets (1) and (2) with four M8×20 hex bolts.
2. Fit brackets (1) and (2) loosely with support plates (1) and (2) using four M4×12 hex bolts, so that the gap between the brackets can be adjusted.
3. Place the mounting plate on the bracket and fix it loosely with four M8×20 hex bolts.

How to fasten the bracket to the mast

1. Drill eight holes of 6.5 mm diameter in the mast and fix the bracket with eight stainless steel rivets (local supply) of 6.4 mm diameter.
2. Tighten the bolts on the bracket.
3. Fasten the radar sensor to the bracket.

Connect the power cable to the power source, observing the guidelines for laying the power cable shown on this page.

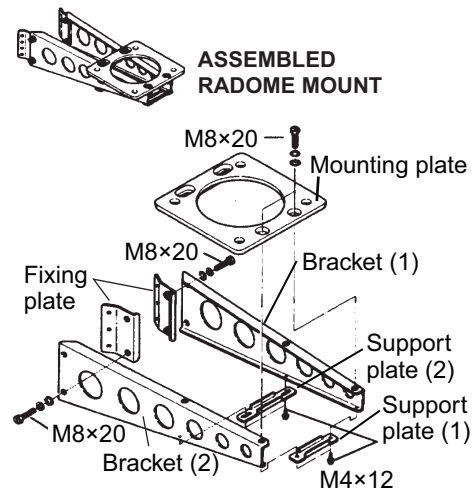

How to assemble the radome mount

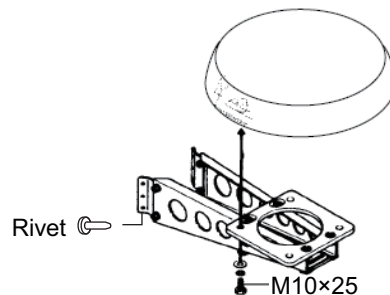

How to fasten the sensor to the radome mount

3.4 How to Set up the Radar Sensor

Before you can set up and use the radar sensor, download and install the free application [Marine Radar] from the App Store. The application is common to both the iPad and the iPhone.

Set up the radar as shown in this section, in the order given.

An insert sheet requests you to attach the supplied SSID and password label to the insert sheet. Attach the label to the sheet, and store the sheet in a safe place for future reference.

3.4.1 How to start the system

Power the sensor. Open your iOS terminal, then turn on the wireless LAN function (in the [Settings] menu) if it is not already on. Tap the [Marine Radar] application (see right figure, appearance subject to change) in your terminal.

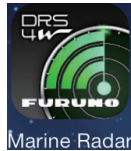

The splash screen appears for a few moments, then the application tries to connect to the radar sensor, which normally takes no more than three seconds. If the connection is successful, the [Preheating] display appears. If the connection could not be made, an error message appears. Tap the [Search again] button to try to connect to the sensor. If the application cannot connect to the sensor, check to see if the wireless LAN function is enabled on your terminal.

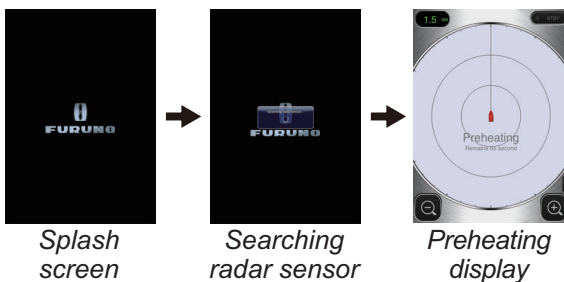

After the preheating is completed, which takes approx. 90 seconds, the radar goes into standby. Tap the STB-TX icon at the top right corner on the display to transmit.

3.4.2 Heading, timing adjustment

How to open the Installation Settings menu

To adjust the heading or timing, you must first open the [Installation Settings] menu.

1. Open the menu, Settings menu:
 - 1) **iPad:** Tap the menu tab at the bottom right corner to open the menu.
iPhone: Tap anywhere to open the menu.
 - 2) **iPad, iPhone:** Tap the Settings menu icon (⚙️) to show the Settings menu.

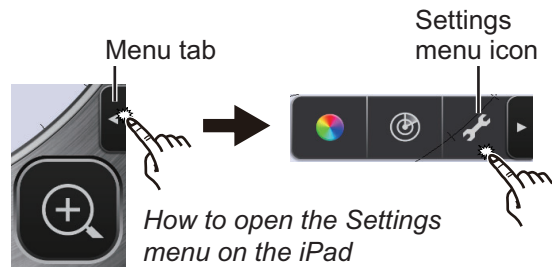

2. Tap [Installation Settings]. You are asked to input the pass code.

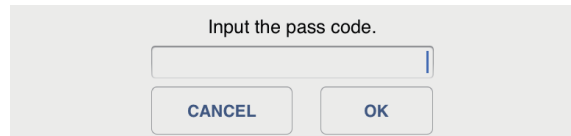

3. Use the software keyboard to enter 1234.

Antenna Rotation	<input checked="" type="checkbox"/>
Jamming	<input checked="" type="checkbox"/>
On Time	000143.3 >
Tx Time	000124.5 >
Video Contrast	2 >
Factory Default	

4. Tap [Back] twice to close the menu and return to the radar display.

Heading alignment

You have mounted the radar sensor facing straight ahead in the direction of the bow. Therefore, a small but conspicuous target dead ahead visually should appear on the heading line (zero degrees).

In practice, you will probably observe some small error on the display because of the difficulty in achieving accurate initial positioning of the sensor. The following adjustment compensates for this error.

1. Open the menu, Picture menu:
 - 1) **iPad:** Tap the menu tab at the bottom right corner to open the menu.
 - iPhone:** Tap anywhere to open the menu.
 - 2) **iPad, iPhone:** Tap the (ⓘ) icon to open the Picture menu.

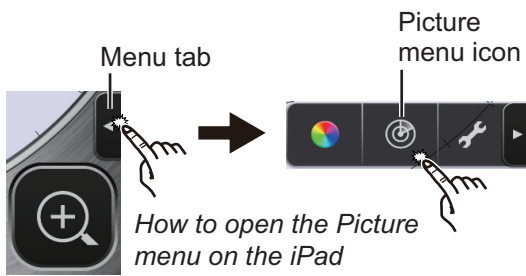

2. Tap the menu navigation buttons (◀▶) to select [Heading Align].

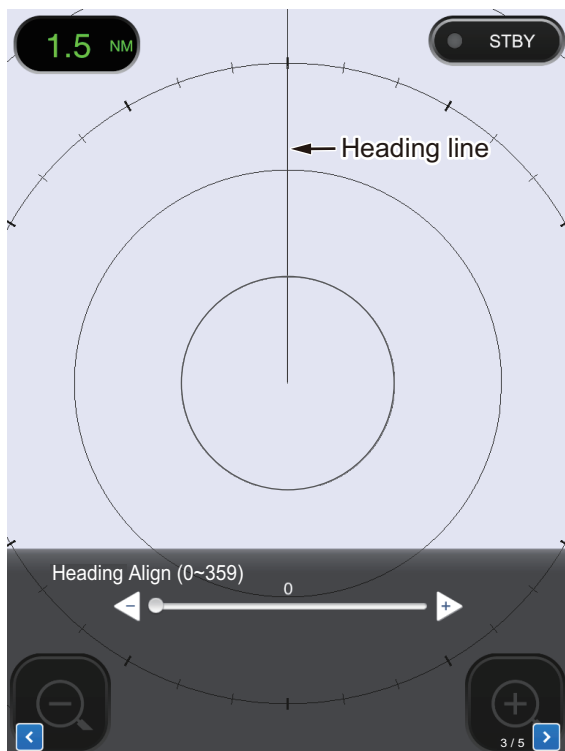

3. Visually identify a suitable target (for example, ship or buoy) at a range between 0.125 to 0.25 miles.
4. Point your boat's bow directly toward the target selected at step 3.
5. Locate the target selected at step 3 on the display and choose a range which places the target in the outer half of the picture.
6. Adjust the slider bar so the target becomes centered on the heading line.

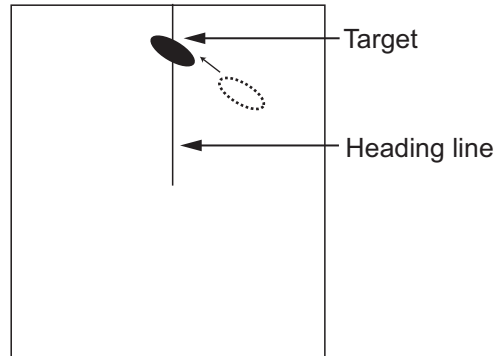

Timing adjustment

The timing is automatically adjusted. However, if a "straight" target (harbor wall, etc.) appears to be pushed or pulled, as shown below, adjust the sweep timing to straighten the target and prevent incorrect placement of all targets.

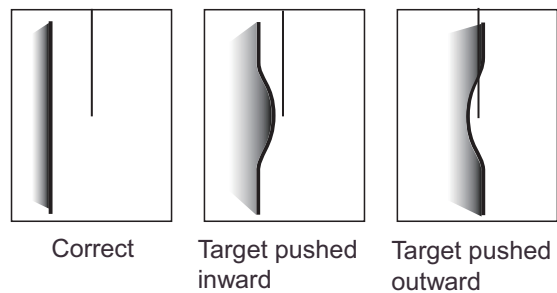

1. Transmit on a range between 0.125 and 0.5 nm.
2. Open the Picture menu, referring to step 1 in "Heading alignment".

3. INSTALLATION

3. Tap the menu navigation buttons (\langle / \rangle) to select [Timing Adjustment].



4. Select [Manual] or [Auto]. For [Auto] go to step 7. For [Manual] go to step 5.
5. Find a target which should be displayed “straightly” (harbor wall, straight pier) on the radar display.
6. While looking at the target selected at step 5, operate the slider bar to straighten the target.
7. Tap the display area to close the window.

3.4.3 Range unit

The range can be shown in nautical miles or kilometers, and the default setting is nautical miles. To change the unit, do as follows:

1. Open the Settings menu, referring to step 1 in “How to open the [Installation Settings] menu” on page 15.
2. Tap [Initial Settings].



3. Tap [Units] then select range unit.

3.4.4 Tuning initialization

Tuning is automatically adjusted when the radar transmits, therefore initialization is not necessary. (Initialization is necessary only when the magnetron is replaced.)

3.4.5 Sector blank

A sector blank is an area on the radar display where no radar echoes appear because an obstruction near the radar sensor (for example, a mast) blocks reception within that area. This area should be marked on the display to alert you that no echoes will be shown there. If you do not have this problem, skip this procedure.

As an example, the procedure below shows how to set a 20° sector blank between 170° and 190°.

1. Open the Picture menu, referring to step 1 in “Heading alignment” on page 16.
2. Tap the item selection buttons (\langle / \rangle) to select [Sector Blank].

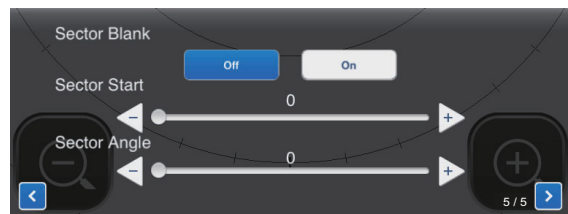

3. Tap the [On] button.
4. At [Sector Start], drag the slider bar to set the start bearing relative to the heading line. (Use the \langle or \triangleright button to fine tune the setting.) In the example, set “170”.
5. At [Sector Angle], drag the slider bar to set the width of the sector. In the example, set “20”.

The sector is marked on the display with dashed green lines.

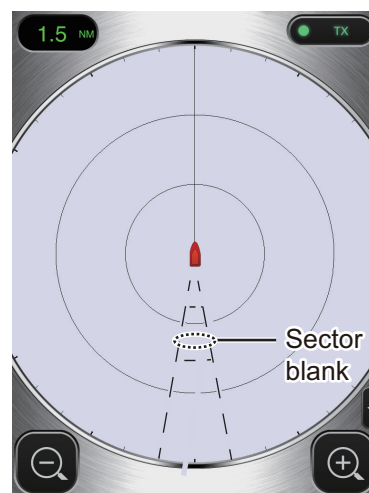

To disable the sector, tap [Off] at [Sector Blank].

APPENDIX 1 MENU TREE

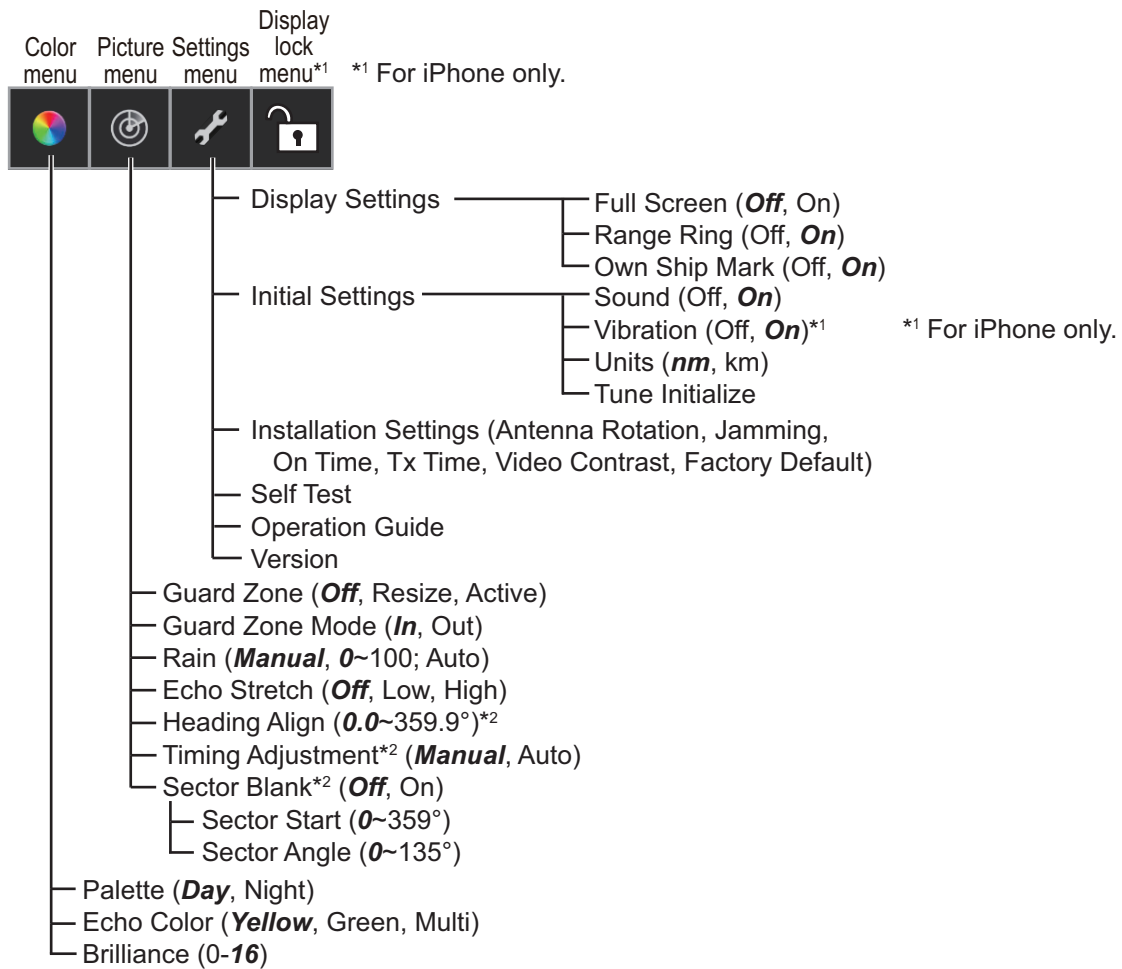

*2 Shown when Installation Setting menu is activated.

APPENDIX 2 RADIO REGULATORY INFORMATION

Wireless interoperability

This product is designed to be interoperable with any wireless LAN product that is based on direct sequence spread spectrum (DSSS) and to comply with the following standard.

- IEEE Std 802.11b Standard on 2.4 GHz Wireless LAN

Safety

This product, like other radio devices, emits radio frequency electromagnetic energy. The level of energy emitted by this device, however, is less than the electromagnetic energy emitted by other wireless devices such as mobile phones. This product operates within the guidelines found in radio frequency safety standards and recommendations. These standards and recommendations reflect the consensus of the scientific community and result from deliberations of panels and committees of scientists who continually review and interpret the extensive research literature. In some situations or environments, the use of this product may be restricted by the proprietor of the building or responsible representatives of the applicable organization. Examples of such situations include the following:

- Using this product onboard airplanes, or
- Using this product in any other environment where the risk of interference with other devices or services is perceived or identified as being harmful.

If uncertain of the policy that applies to the use of wireless devices in a specific organization or environment (an airplane, for example), ask for authorization to use this product before turning it on.

Export Regulation

Radio wave certification is necessary at the export destination. The Wireless LAN of this product operates in the 2.4 GHz band, which does not require a license in most countries. However, the conditions for use of the wireless LAN depend on the country or the area.

USA-Federal Communications Commission

This equipment has been tested and found to comply with the limits for a Class B digital device, pursuant to Part 15 of FCC Rules. These limits are designed to provide reasonable protection against harmful interference in a residential installation. This equipment generates, uses, and can radiate radio frequency energy. If not installed and used in accordance with the instructions, it may cause harmful interference to radio communications. However, there is no guarantee that interference will not occur in a particular installation.

If this equipment does cause harmful interference to radio or television reception, which can be determined by tuning the equipment off and on, the user is encouraged to try and correct the interference by one or more of the following measures:

- Reorient or relocate the receiving antenna.
- Increase the distance between the equipment and the receiver.
- Connect the equipment to outlet on a circuit different from that to which the receiver is connected.
- Consult the dealer or an experienced radio/TV technician for help.

This device complies with part 15 of the FCC Rules. Operation is subject to the following two conditions: (1) This device may not cause harmful interference, and (2) this device must accept any interference received, including interference that may cause undesired operation.

Any changes or modifications not expressly approved by the party responsible for compliance could void the user's authority to operate the equipment.

Caution: Exposure to Radio Frequency Radiation

- This equipment complies with FCC radiation exposure limits set forth for an uncontrolled environment and meets the FCC radio frequency (RF) Exposure Guidelines in Supplement C to OET65.
- This equipment should be installed and operated keeping the radiator at least 20cm or more away from person's body.
- This device must not be co-located or operating in conjunction with any other antenna or transmitter, except in accordance with FCC and Industry Canada multi-transmitter RF Exposure procedures.

Canada-Industry Canada (IC)

This device complies with RSS 210 of Industry Canada. Operation is subject to the following two conditions:

- (1) This device may not cause interference, and
- (2) This device must accept any interference, including interference that may cause undesired operation of this device.

L'utilisation de ce dispositif est autorisée seulement aux conditions suivantes:

- (1) il ne doit pas produire de brouillage et.
- (2) l'utilisateur du dispositif doit être prêt à accepter tout brouillage radioélectrique reçu, même si ce brouillage est susceptible de compromettre le fonctionnement du dispositif.

Caution: Exposure to Radio Frequency Radiation

This equipment complies with IC radiation exposure limits set forth for an uncontrolled environment and meets RSS-102 of the IC radio frequency (RF) Exposure rules. This equipment should be installed and operated keeping the radiator at least 20cm or more away from person's body.

Cet équipement est conforme aux limites d'exposition aux rayonnements énoncées pour un environnement non contrôlé et respecte les règles d'exposition aux fréquences radioélectriques (RF) CNR-102 de l'IC. Cet équipement doit être installé et utilisé en gardant une distance de 20 cm ou plus entre le dispositif rayonnant et le corps.

To reduce potential radio interference to other users, the antenna type and its gain should be so chosen that the equivalent isotropically radiated power (EIRP) is not more than that required for successful communication.

**SPECIFICATIONS OF RADAR SENSOR
DRS4W**

1 RADIATOR

- 1.1 Antenna type Patch array antenna
- 1.2 Antenna length 15-inch
- 1.3 Horizontal beam width 7.2° (3 dB)
- 1.4 Vertical beam width 25° (3 dB)
- 1.5 Gain 20 dBi or more
- 1.6 Sidelobe attenuation -18 dB (within ±20°), -20 dB (±20° or more)
- 1.7 Rotation 24 rpm

2 RADAR FUNCTION

- 2.1 Tx frequency 9410±30 MHz, P0N
- 2.2 Output power 4 kW
- 2.3 Duplexer Ferrite circulator
- 2.4 Intermediate frequency 60 MHz
- 2.5 Range, Pulse length and Pulse repetition rate

Range (NM)	Pulse length (μs)	PRR (Hz approx.)
0.125 to 0.5	0.08	360
0.75 to 2	0.3	360
3 to 24	0.8	360

- 2.6 Minimum range 25 m
- 2.7 Range resolution 25 m
- 2.8 Range accuracy 1 % of range in use or 0.01 NM, which is the greater
- 2.9 Bearing resolution 7.2°
- 2.10 Bearing accuracy ±1°
- 2.11 Warming up time 90 s

3 INTERFACE

- 3.1 Wireless LAN standard IEEE 802.11 b
- 3.2 Transmit frequency 2.4GHz nominal
- 3.3 Number of channel 10 ch
- 3.4 Receivable distance 10 m nominal

4 POWER SUPPLY

12-24 VDC: 2.1/1.0 A

5 ENVIRONMENTAL CONDITIONS

- 5.1 Ambient temperature -25°C to +55°C
- 5.2 Relative humidity 95% or less at +40°C
- 5.3 Degree of protection IP26
- 5.4 Vibration IEC 60945 Ed.4

6 UNIT COLOR

N9.5 (cover), PANTONE 2945C (bottom)

PACKING LIST

03HN-X-9853 -0 1/1

DRS4W-EU

A-1

NAME	OUTLINE	DESCRIPTION/CODE No.	QTY
ユニット UNIT			
レーダセンサー RADAR SENSOR		RSB-126-103-EU 000-027-222-00	1
予備品 SPARE PARTS			
予備品 SPARE PARTS		SP03-17801 001-265-910-00	1
工事材料 INSTALLATION MATERIALS			
工事材料 INSTALLATION MATERIALS		CP03-35701 001-265-920-00	1
図書 DOCUMENT			
パスワード情報 PASSWORD INFO		E32-01401-* 000-179-453-1*	1
型紙 TEMPLATE		E32-01314-* 000-178-948-1*	1
使用上の御注意 NOTES ON USAGE		E32-01405-* 000-179-823-1*	1
取扱説明書(英) OPERATOR'S MANUAL (EN)		OME-36360-* 000-178-946-1*	1

型式/コード番号が2段の場合、下段より上段に代わる過渡期品であり、どちらかが入っています。なお、品質は変わりません。

TWO TYPES AND CODES MAY BE LISTED FOR AN ITEM. THE LOWER PRODUCT MAY BE SHIPPED IN PLACE OF THE UPPER PRODUCT. QUALITY IS THE SAME.

(略図の寸法は、参考値です。DIMENSIONS IN DRAWING FOR REFERENCE ONLY.)

表 1 TABLE 1

寸法区分 (mm) DIMENSION	公差 (mm) TOLERANCE
L ≤ 50	± 1.5
50 < L ≤ 100	± 2.5
100 < L ≤ 500	± 3

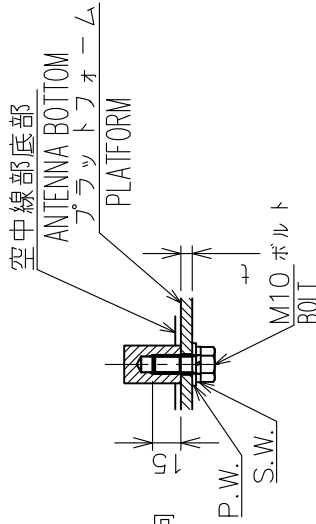
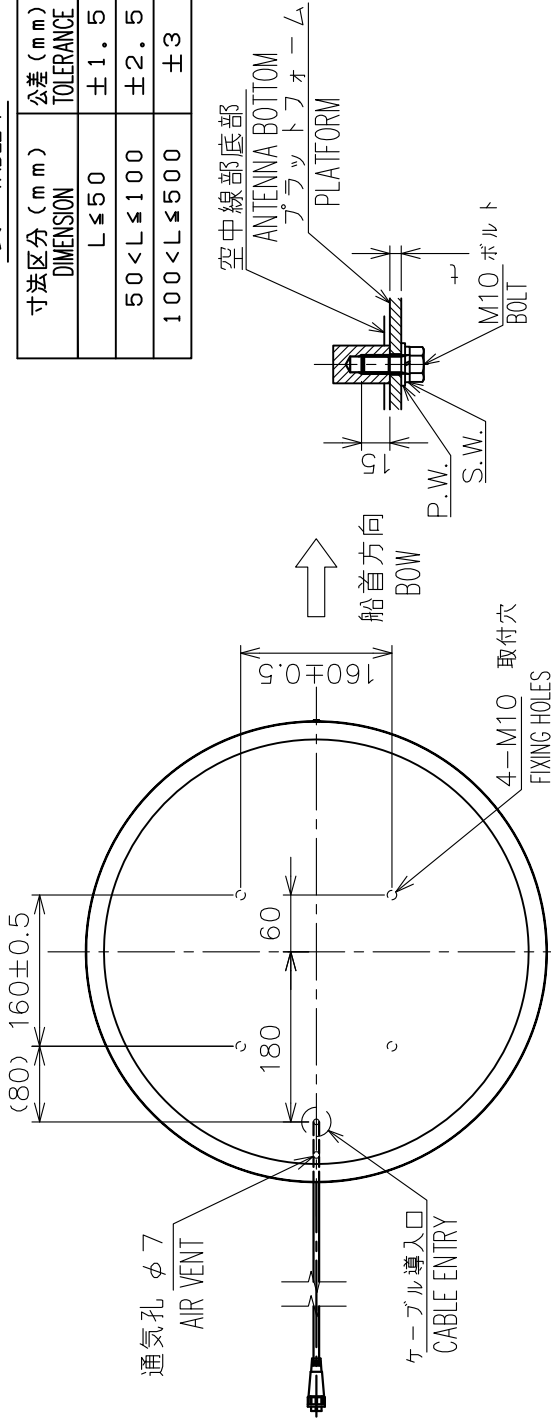

A 部 詳細 (尺度: 1/4)
DETAIL OF A (SCALE: 1/4)

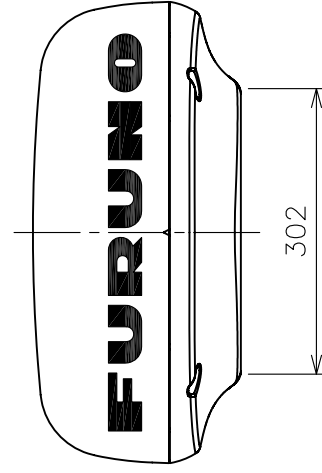
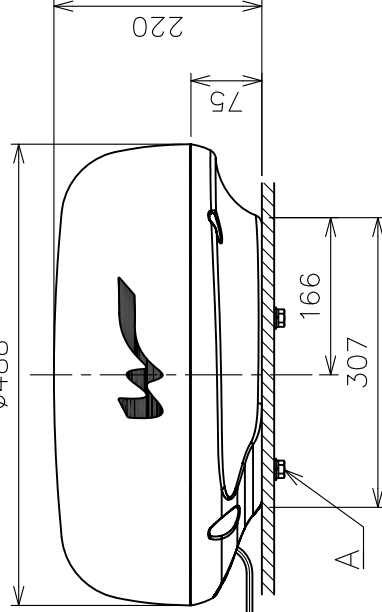
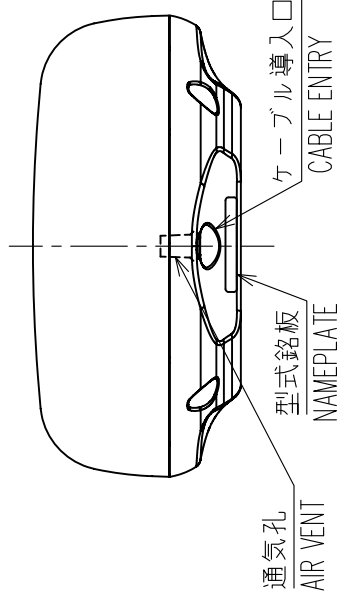

注 記

- 指定外の寸法公差は表 1 による。
- 取付用ネジは M10 ボルトを使用のこと。ネジ長さは板厚 (t) に応じ、 $20 (t \leq 5)$ または $25 (5 < t \leq 10)$ とする。

NOTE

- TABLE 1 INDICATES TOLERANCE OF DIMENSIONS WHICH IS NOT SPECIFIED.
- USE M10 BOLTS FOR FIXING THE UNIT. SCREW LENGTH SHOULD BE $20 (t \leq 5)$ OR $25 (5 < t \leq 10)$. t: THICKNESS OF PLATFORM.

DRAWN	29/Jan/2014	T. YAMASAKI	TITLE	RSB-126-103
CHECKED	29/Jan/2014	H. MAKI	名称	レーダーセンサー
APPROVED	30/Jan/2014	H. MAKI	外寸図	
SCALE	1/8	質量はケーブル (1m) を含む。 #10M 質量はケーブル (1m) を含む。 t: MASS 5.7 kg	NAME	RADAR SENSOR
DWG.No.	C:3636-G01-A	REF.No.	03-184-300G-1	OUTLINE DRAWING

4

3

2

A

B

C

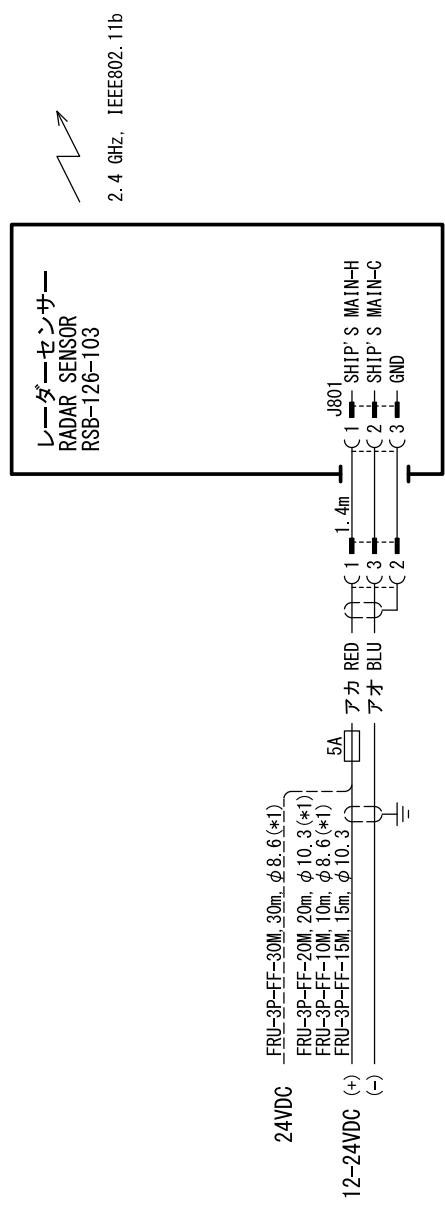

注記

*1) オプション。

NOTE

*1: OPTION.

DRAWN	20/Jan/2016	T. YAMASAKI	TITLE	DRS4W
CHECKED	20/Jan/2016	H. MAKI	名称	レーダーセンサー
APPROVED	20/Jan/2016	H. MAKI		相互結線図
SCALE	MASS	kg	NAME	RADAR SENSOR
DWG. No.	C3636-C01-C	REF. No.	03-184-6011-1	INTERCONNECTION DIAGRAM

FURUNO Worldwide Warranty for Pleasure Boats (Except North America)

This warranty is valid for products manufactured by Furuno Electric Co. (hereafter FURUNO) and installed on a pleasure boat. Any web based purchases that are imported into other countries by anyone other than a FURUNO certified dealer may not comply with local standards. FURUNO strongly recommends against importing these products from international websites as the imported product may not work correctly and may interfere with other electronic devices. The imported product may also be in breach of the local laws and mandated technical requirements. Products imported into other countries as described previously shall not be eligible for local warranty service.

For products purchased outside of your country please contact the national distributor of Furuno products in the country where purchased.

This warranty is in addition to the customer's statutory legal rights.

1. Terms and Conditions of Warranty

FURUNO guarantees that each new FURUNO product is the result of quality materials and workmanship. The warranty is valid for a period of 2 years (24 months) from the date of the invoice, or the date of commissioning of the product by the installing certified dealer.

2. FURUNO Standard Warranty

The FURUNO standard warranty covers spare parts and labour costs associated with a warranty claim, provided that the product is returned to a FURUNO national distributor by prepaid carrier.

The FURUNO standard warranty includes:

- Repair at a FURUNO national distributor
- All spare parts for the repair
- Cost for economical shipment to customer

3. FURUNO Onboard Warranty

If the product was installed/commissioned and registered by a certified FURUNO dealer, the customer has the right to the onboard warranty.

The FURUNO onboard warranty includes

- Free shipping of the necessary parts
- Labour: Normal working hours only
- Travel time: Up to a maximum of two (2) hours
- Travel distance: Up to a maximum of one hundred and sixty (160) KM by car for the complete journey

4. Warranty Registration

For the Standard Warranty - presentation of product with serial number (8 digits serial number, 1234-5678) is sufficient. Otherwise, the invoice with serial number, name and stamp of the dealer and date of purchase is shown.

For the Onboard Warranty your FURUNO certified dealer will take care of all registrations.

5. Warranty Claims

For the Standard Warranty - simply send the defective product together with the invoice to a FURUNO national distributor. For the Onboard Warranty – contact a FURUNO national distributor or a certified dealer. Give the product's serial number and describe the problem as accurately as possible.

Warranty repairs carried out by companies/persons other than a FURUNO national distributor or a certified dealer is not covered by this warranty.

6. Warranty Limitations

When a claim is made, FURUNO has a right to choose whether to repair the product or replace it.

The FURUNO warranty is only valid if the product was correctly installed and used. Therefore, it is necessary for the customer to comply with the instructions in the handbook. Problems which result from not complying with the instruction manual are not covered by the warranty.

FURUNO is not liable for any damage caused to the vessel by using a FURUNO product.

The following are excluded from this warranty:

- a. Second-hand product
- b. Underwater unit such as transducer and hull unit
- c. Routine maintenance, alignment and calibration services.
- d. Replacement of consumable parts such as fuses, lamps, recording papers, drive belts, cables, protective covers and batteries.
- e. Magnetron and MIC with more than 1000 transmitting hours or older than 12 months, whichever comes first.
- f. Costs associated with the replacement of a transducer (e.g. Crane, docking or diver etc.).
- g. Sea trial, test and evaluation or other demonstrations.
- h. Products repaired or altered by anyone other than the FURUNO national distributor or an authorized dealer.
- i. Products on which the serial number is altered, defaced or removed.
- j. Problems resulting from an accident, negligence, misuse, improper installation, vandalism or water penetration.
- k. Damage resulting from a force majeure or other natural catastrophe or calamity.
- l. Damage from shipping or transit.
- m. Software updates, except when deemed necessary and warrantable by FURUNO.
- n. Overtime, extra labour outside of normal hours such as weekend/holiday, and travel costs above the 160 KM allowance
- o. Operator familiarization and orientation.

FURUNO Electric Company, March 1, 2011

FURUNO Warranty for North America

FURUNO U.S.A., Limited Warranty provides a twenty-four (24) months LABOR and twenty-four (24) months PARTS warranty on products from the date of installation or purchase by the original owner. Products or components that are represented as being waterproof are guaranteed to be waterproof only for, and within the limits, of the warranty period stated above. The warranty start date may not exceed eighteen (18) months from the original date of purchase by dealer from Furuno USA and applies to new equipment installed and operated in accordance with Furuno USA's published instructions.

Magnetrons and Microwave devices will be warranted for a period of 12 months from date of original equipment installation.

Furuno U.S.A., Inc. warrants each new product to be of sound material and workmanship and through its authorized dealer will exchange any parts proven to be defective in material or workmanship under normal use at no charge for a period of 24 months from the date of installation or purchase.

Furuno U.S.A., Inc., through an authorized Furuno dealer will provide labor at no cost to replace defective parts, exclusive of routine maintenance or normal adjustments, for a period of 24 months from installation date provided the work is done by Furuno U.S.A., Inc. or an AUTHORIZED Furuno dealer during normal shop hours and within a radius of 50 miles of the shop location.

A suitable proof of purchase showing date of purchase, or installation certification must be available to Furuno U.S.A., Inc., or its authorized dealer at the time of request for warranty service.

This warranty is valid for installation of products manufactured by Furuno Electric Co. (hereafter FURUNO). Any purchases from brick and mortar or web-based resellers that are imported into other countries by anyone other than a FURUNO certified dealer, agent or subsidiary may not comply with local standards. FURUNO strongly recommends against importing these products from international websites or other resellers, as the imported product may not work correctly and may interfere with other electronic devices. The imported product may also be in breach of the local laws and mandated technical requirements. Products imported into other countries, as described previously, shall not be eligible for local warranty service.

For products purchased outside of your country please contact the national distributor of Furuno products in the country where purchased.

WARRANTY REGISTRATION AND INFORMATION

To register your product for warranty, as well as see the complete warranty guidelines and limitations, please visit www.furunousa.com and click on "Support". In order to expedite repairs, warranty service on Furuno equipment is provided through its authorized dealer network. If this is not possible or practical, please contact Furuno U.S.A., Inc. to arrange warranty service.

FURUNO U.S.A., INC.
Attention: Service Coordinator
4400 N.W. Pacific Rim Boulevard
Camas, WA 98607-9408
Telephone: (360) 834-9300
FAX: (360) 834-9400

Furuno U.S.A., Inc. is proud to supply you with the highest quality in Marine Electronics. We know you had several choices when making your selection of equipment, and from everyone at Furuno we thank you. Furuno takes great pride in customer service.

Declaration of Conformity



We **FURUNO ELECTRIC CO., LTD.**

(Manufacturer)

9-52 Ashihara-Cho, Nishinomiya City, 662-8580, Hyogo, Japan

(Address)

declare under our sole responsibility that the product

RADAR SENSOR DRS4W

(Model name, type number)

is in conformity with the essential requirements as described in the Directive 1999/5/EC of the European Parliament and of the Council of 9 March 1999 on radio equipment and telecommunications terminal equipment (R&TTE Directive) and satisfies all the technical regulations applicable to the product within this Directive

IEC 60950-1 Ed.2.0: 2005 Safety related items	ITU-R M.1177-4: Spurious related items
IEC 60950-1 Ed.2.0 A1: 2009 Safety related items	ITU-R SM.1539-1: Spurious related items
IEC 60950-1 Ed.2.0 A2: 2013 Safety related items	ITU-R SM.1541-4: Spurious related items
IEC 62311 Ed.1.0: 2007 Safety related items	ITU-R SM. 329-11: Spurious related items
IEC 60945 Ed.4.0: 2002 Safety and EMC related items	ETSI EN 300 328 V1.8.1: 2012 Spurious related items
ETSI EN 301 489-1 V1.9.2: 2011 EMC related items	IEC 62252 Ed.1.0: 2004 (clauses 4.33, 5.33, Annex D)
ETSI EN 301 489-17 V2.2.1: 2012 EMC related items	Spurious related items
ETSI EN 301 843-1 V1.3.1: 2012 EMC related items	
ETSI EN 302 248 V1.2.1: 2013 EMC and spurious related items	

(title and/or number and date of issue of the standard(s) or other normative document(s))

For assessment, see

- Statement of Opinion No: AN14C10701 issued by UL Verification Services, USA.

On behalf of Furuno Electric Co., Ltd.

Nishinomiya City, Japan
December 19, 2014

(Place and date of issue)

Yoshitaka Shogaki
Department General Manager
Quality Assurance Department

(name and signature or equivalent marking of authorized person)

ECF

(Elemental Chlorine Free)

The paper used in this manual
is elemental chlorine free.

FURUNO ELECTRIC CO., LTD.

9-52 Ashihara-cho,
Nishinomiya, 662-8580, JAPAN

• FURUNO Authorized Distributor/Dealer

All rights reserved. Printed in Japan

Pub. No. OME-36360-C4

(ETMI) DRS4W

A : MAR. 2014

C4 : AUG. 22, 2016



0 0 0 1 7 8 9 4 6 1 2